

TA-AV480

SERVICE MANUAL

US Model
Canadian Model
AEP Model
UK Model
E Model



SPECIFICATIONS

US MODEL

AUDIO POWER SPECIFICATIONS POWER OUTPUT AND TOTAL HARMONIC DISTORTION:

With 8 ohm loads both channels driven,
from 20 — 20,000 Hz; rated 120 watts per
channel minimum RMS power, with no
more than 0.08% total harmonic distortion
from 250 milliwatts to rated output.

Other specifications

Amplifier section

Power bandwidth (IHF)

7 Hz — 30 kHz (8 ohm)

Harmonic distortion

Less than 0.08% (at 1 kHz, 8-ohm load, Front
US, Canadian, E MODEL: 120W + 120W, Surround OFF
AEP, UK MODEL: 75W + 75W, Surround OFF)

Intermodulation (IM) distortion (60 Hz : 7 kHz)

Less than 0.08% at rated output

Frequency response

PHONO: RIAA equalization curve ± 0.5 dB
TUNER, CD, GRAPHIC EQ, TAPE, VIDEO 1, 2, 3,
4: 10 Hz to 70 kHz, ± 3 dB

Residual noise Less than 25 μ V (8 ohms, network A)

Damping factor 50 (8 ohms, 1 kHz)

Video section

Video input/output

Permissible signal input level

1.5 Vp-p

Output signal level

1 + 0.1 Vp-p/with 1 Vp-p input
(measured at MONITOR OUT)

Impedance (output)

75-ohm unbalanced, negative sync

Input

Input jack		Jack type	Sensitivity	Impedance
PHONO	MM	Phono	2.0 mV	50 kilohms
TUNER CD VIDEO 1, 2, 3, 4 (CDV) TAPE		Phono	150 mV	50 kilohms

Output

REC OUT	Phono jacks	Voltage 150 mV Impedance 470 kilohm
SPEAKERS	—	Accepts speakers of 8 — 16 ohms.
HEADPHONES	Stereo phone jack	Accepts low and high impedance headphones.
VIDEO 1, 2, MONITOR	S jack	1 Vp-p, 75 Ω

Tone controls

	Response
BASS	± 10 dB (100 Hz)
TREBLE	± 8 dB (10 kHz)

— Continued on page 2 —



INTEGRATED STEREO
AV AMPLIFIER
SONY®

General

System	
Power amplifier	All-stage direct-coupled pure complementary SEPP OCL circuit
Surround amplifier	Semi complementary SEPP circuit
Preamplifier	NF type tone control
Surround circuit	Operation circuit matrix type
Overall output	Front 120W + 120W (US, Canadian, E) Front 75W + 75W (AEP, UK) Surround 15W + 15W (US, Canadian, E) Surround 12.5W + 12.5W (AEP, UK)
Dolby input sensitivity	500 mV
Power requirements	120V AC (US, Canadian), 220V AC (AEP), 240V AC (UK), 120–220V AC (E)
Power consumption	US model: 200W Canadian: 450VA AEP, UK model: 170W E model: 220W
AC Power outlet	3 switched outputs for system, 100W
Dimensions	430x130x325 (W/H/D) (18x5 $\frac{1}{4}$ x15 inches)
Weight	Approx. 9.2kg (20 lb 5oz) (Canadian, UK) Approx. 9.9kg (21 lb 13oz) (US, E) Approx. 8.5kg (18 lb 12oz) (AEP)
Accessories supplied	Programmable remote commander RM-P102 (1). Sony SUM-3 (NS) batteries (4).

FEATURES

Amplifier Features

- This amplifier incorporates the power amplifier for the front speakers (US, Canadian, E: 120W + 120W/AEP, UK: 75W + 75W) and that for the surround speakers (US, Canadian, E: 15W + 15W/AEP, UK: 12.5W + 12.5W) independently. These amplifiers make possible a powerful surrounding sound from 4 speakers.
- The versatile input system controls 4 A/V input systems and 4 audio input systems.

Surround Features

This unit incorporates all of three types of surround effect.

-  * — expands sound just like listening to it in a movie theater.
- Hall Surround — provides reverberation effect that is produced in a large concert hall.
- Simulated Surround — gives the feeling of width and thickness to monaural sound of old movies, etc.

Programmable Remote Commander

- The supplied programmable commander is capable of "learning" the remote control signals used with other remote commanders. The single commander can replace them for controlling various audio and video equipment of any manufacturers, thereby frees you from complicated manipulation of several remote commanders.

* "DOLBY" and the double-D symbol  are trademarks of Dolby Laboratories Licensing Corporation.

SAFETY CHECK-OUT

After correcting the original service problem, perform the following safety check before releasing the set to the customer:

Check the antenna terminals, metal trim, "metallized" knobs, screws, and all other exposed metal parts for AC leakage. Check leakage as described below.

LEAKAGE TEST

The AC leakage from any exposed metal part to earth ground and from all exposed metal parts to any exposed metal part having a return to chassis, must not exceed 0.5 mA (500 microamperes). Leakage current can be measured by any one of three methods.

1. A commercial leakage tester, such as the Simpson 229 or RCA WT-540A. Follow the manufacturers' instructions to use these instruments.
2. A battery-operated AC milliammeter. The Data Precision 245 digital multimeter is suitable for this job.
3. Measuring the voltage drop across a resistor by means of a VOM or battery-operated AC voltmeter. The "limit" indication is 0.75 V, so analog meters must have an accurate low-voltage scale. The Simpson 250 and Sanwa SH-63Trd are examples of a passive VOM that is suitable. Nearly all battery operated digital multimeters that have a 2 V AC range are suitable. (See Fig. A)

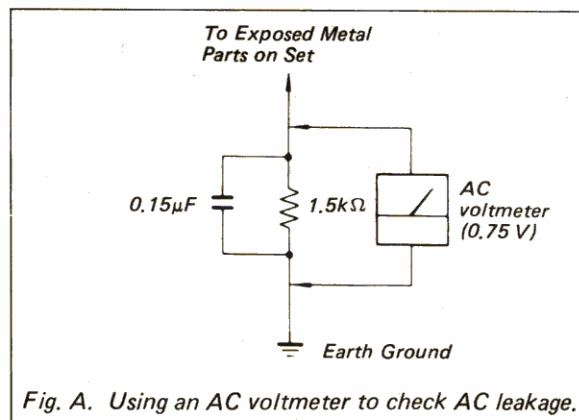



Fig. A. Using an AC voltmeter to check AC leakage.

SAFETY-RELATED COMPONENT WARNING!!

COMPONENTS IDENTIFIED BY MARK  OR DOTTED LINE WITH MARK  ON THE SCHEMATIC DIAGRAMS AND IN THE PARTS LIST ARE CRITICAL TO SAFE OPERATION. REPLACE THESE COMPONENTS WITH SONY PARTS WHOSE PART NUMBERS APPEAR AS SHOWN IN THIS MANUAL OR IN SUPPLEMENTS PUBLISHED BY SONY.

ATTENTION AU COMPOSANT AYANT RAPPORT À LA SÉCURITÉ!

LES COMPOSANTS IDENTIFIÉS PAR UNE MARQUE  SUR LES DIAGRAMMES SCHÉMATIQUES ET LA LISTE DES PIÈCES SONT CRITIQUES POUR LA SÉCURITÉ DE FONCTIONNEMENT. NE REMPLACER CES COMPOSANTS QUE PAR DES PIÈCES SONY DONT LES NUMÉROS SONT DONNÉS DANS CE MANUEL OU DANS LES SUPPLÉMENTS PUBLIÉS PAR SONY.

TABLE OF CONTENTS

<u>Section</u>	<u>Title</u>	<u>Page</u>	<u>Section</u>	<u>Title</u>	<u>Page</u>
Specifications		1	3-3. Schematic Diagram		
Safety Check-out		2	(Video Section)		9
Features		2	3-4. IC Block Diagram		12
SECTION 1. GENERAL		3	3-5. Printed Wiring Boards (Main Section) . .		13
SECTION 2. ADJUSTMENTS		4	3-6. Schematic Diagram (Main Section) . . .		17
SECTION 3. DIAGRAMS			SECTION 4. EXPLODED VIEW		23
3-1. Semiconductor Lead Layouts		5	SECTION 5. ELECTRICAL PARTS LIST . . .		24
• Circuit Boards Location		5	SECTION 6. TROUBLE SHOOTING		32
3-2. Printed Wiring Boards					
(Video Section)		6			

SECTION 1 GENERAL

Parts Identification of the remote commander (RM-P102)

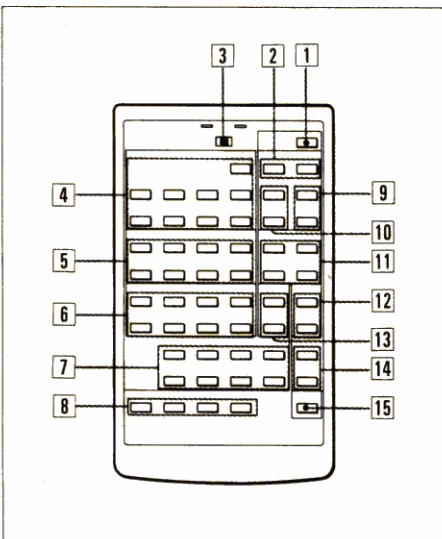

Note on programmable commander

When operating the programmable commander the remote control sensor should be protected from strong light such as direct sunlight and the light of lighting equipment. Otherwise, the remote-control operation could be impossible.

4 VTR control buttons

5 TAPE (cassette deck) control buttons

6 CD player control buttons

Caution:

With some CD players from Sony, the shuffle and program operation may not be able to be canceled. In this case, program these functions in the programmable remote commander, or simply press the CONTINUE button on the CD player.

7 FUNCTION selectors

8 SURROUND selectors

OFF, DOLBY, HALL, SIMULATED

9 TV VOL (volume) +/- buttons

10 TV CH (channel) +/- buttons

11 A, B, C, D control buttons

These buttons have no pre-assigned functions.

12 TUNER PRESET CH (channel) +/- buttons

13 PHONO START/STOP buttons

14 VOL (volume) +/- buttons

15 MUTING button

The following functions are available with the mode switch set to SONY STD.

1 POWER ON/OFF button

2 POWER ON/OFF buttons

VTR: Turns on/off the VCR

TV: Turns on/off the TV set

3 Mode selector

SONY STD: To control the operations of the equipment manufactured by Sony.

USER STD: To control the programmed operation if there is any operation programmed under a key, or to control the Sony equipment operation if there is no operation programmed under it.

LEARN: To program the signals of other infrared remote commanders under the keys of the programmable commander.

Note

Pressing the ● and ▷ buttons sets the VCR to the recording mode. For some Sony VCRs, pressing the ● button sets the VCR to recording pause mode.

At that time, press the ■ button to set to the recording mode.

Installing Batteries

1

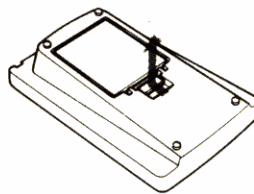

2 four size "AA" (R6) batteries.

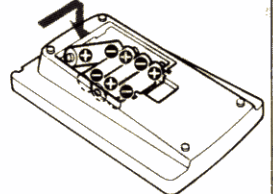

Notes on batteries

Battery life

About a half year of normal operation can be expected when using the Sony SUM-3 (NS) batteries.

When the batteries are exhausted, the remote commander cannot operate the unit or programming is not possible. If this happens, replace four batteries with new ones.

To avoid battery leakage

When the commander is not to be used for a long time, remove the batteries to avoid damage caused by battery leakage and corrosion.

SECTION 2 ADJUSTMENTS

After removing of POWER TRANSISTOR, check the following transistors to prevent from another damaging of POWER TRANSISTOR replaced.

Q501, 503 ~ 507, 509 ~ 512,
Q601, 603 ~ 607, 609 ~ 612.

Note: When POWER TRANSISTOR or the transistors above are replaced, perform this adjustment.

DC BIAS Adjustment

Setting:

With no signal input (without DUMMY LOAD)
VOLUME control: minimum

Procedure:

1. Connect the DC millivoltmeter to TP1.
2. Turn on the power of the set and wait for a few minutes for warm-up.

Adjustment point	Reading on DC millivoltmeter	
TP1	less than 5mV	normal (no adjustment)
TP1	more than 5mV	Re-solder the soldering portion: <div style="display: flex; justify-content: space-around; width: 100%;"> R528, R628 R514, R614 </div> <div style="display: flex; justify-content: space-around; width: 100%; margin-top: 5px;"> Parallel Parallel </div>

MAIN BOARD
[Component Side]

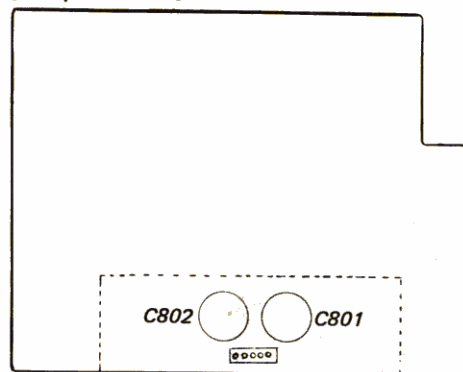



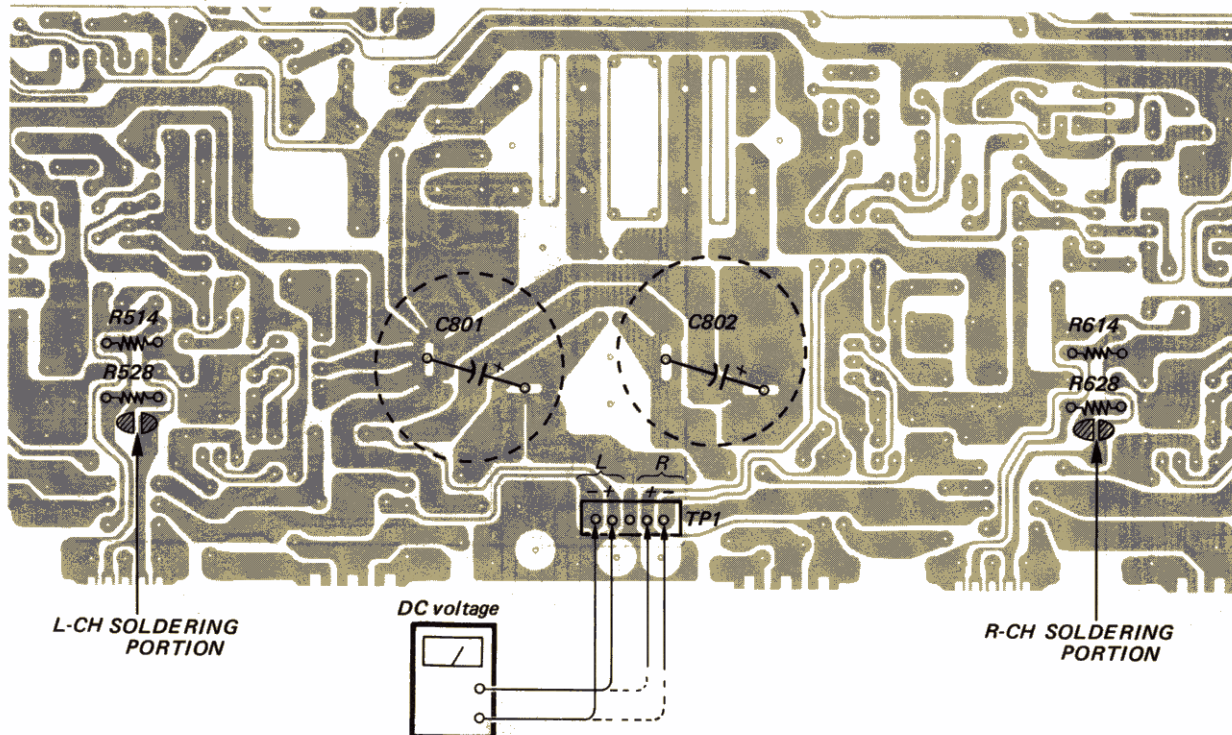





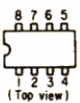

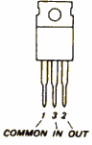

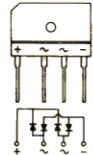
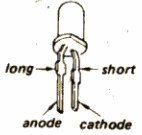
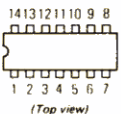
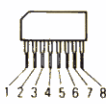

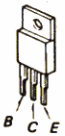
Adjustment Location: MAIN BOARD

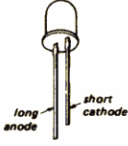
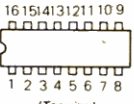
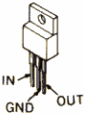

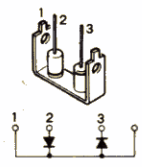
SECTION 3 DIAGRAMS

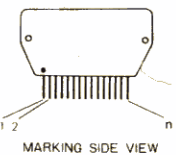
3-1. SEMICONDUCTOR LEAD LAYOUTS

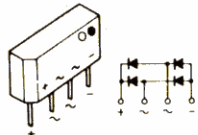
<p>MN-3007 MN-3101</p>  <p>(Top view)</p>	<p>M50720-401SP</p>  <p>(Top view)</p>	<p>M5F7909</p>  <p>COMMON IN OUT</p>	<p>DTA114ES DTA124ES DTC114ES DTC124ES 2SD1387</p>  <p>E C B</p>	<p>RBV-402-01</p> 	<p>SEL2210S SEL2910A</p>  <p>long short anode cathode</p>
<p>M4066BP</p>  <p>(Top view)</p>	<p>M5218L μPC1237HA</p>  <p>1 2 3 4 5 6 7 8</p>	<p>2SB1014</p>  <p>E B C</p>	<p>2SA985A 2SA1383 2SC2275A 2SC3514</p>  <p>B C E</p>	<p>US1060M US1090M UZL-6L2 10E2N</p>  <p>cathode anode</p>	<p>SEL2510C</p>  <p>long anode short cathode</p>
<p>NE646N TC4052BP</p>  <p>(Top view)</p>	<p>M5F7809</p>  <p>IN GND OUT</p>	<p>2SC1847 2SC3622A 2SD1388</p>  <p>E C B</p>	<p>2SA979</p>  <p>B C E B</p>	<p>D300</p> 	<p>SEL4925A-C</p>  <p>long anode short cathode</p>
<p>LC7822</p>  <p>(Top view)</p>	<p>STK-4026</p>  <p>MARKING SIDE VIEW</p>	<p>2SA988</p>  <p>E C B</p>	<p>2SA1175 2SC2785</p>  <p>letter side B C E B</p>	<p>S1VB10</p> 	

● CIRCUIT BOARDS LOCATION

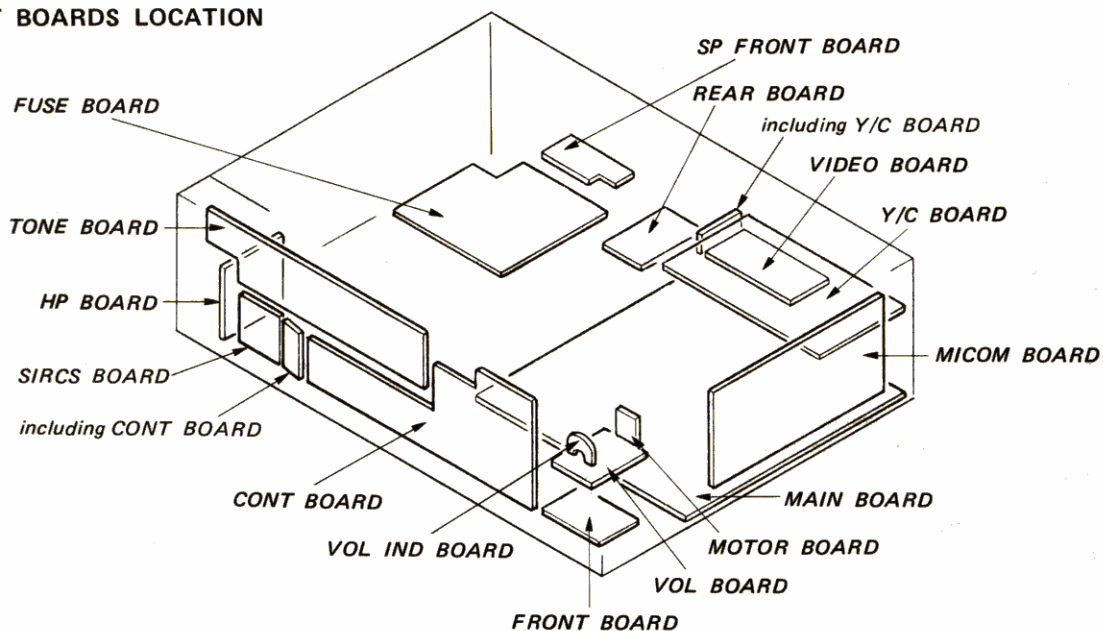

3-2. PRINTED WIRING BOARDS

— Video Section —

● Semiconductor Location (Control)

Ref. No.	Location	Ref. No.	Location
D50	F-5	Q52	F-4
D51	F-5	Q53	H-4
D807	B-6	Q54	I-4
D900	H-12	Q55	H-4
D901	I-12	Q56	K-3
D902	C-9	Q57	K-3
D903	C-10	Q58	J-3
D904	C-11	Q900	H-13
D905	C-12	Q901	H-13
D906	B-9	Q902	H-13
D907	B-10	Q903	H-13
D908	B-11	Q904	I-13
D909	B-12	Q905	I-13
D910	B-13	Q906	G-12
D911	B-14	Q907	F-12
D912	B-15	Q908	G-12
D913	B-16	Q909	G-12
D914	B-13	Q910	H-12
D915	C-13	Q911	H-12
D916	H-9	Q912	H-12
D917	H-9	Q913	H-12
D918	I-10	Q914	H-12
D919	D-15	Q915	H-12
D920	I-9	Q916	H-10
D921	I-9	Q917	I-10
D922	I-14	Q920	I-9
D923	C-14	Q921	I-12
D924	C-15	Q922	I-12
D925	C-16	Q923	G-10
D931	J-12	Q924	G-10
—	—	Q925	G-9
IC50	I-4	Q926	G-9
IC51	F-5	Q927	H-14
IC900	H-11	Q928	I-14
IC901	B-5	Q929	G-10
—	—	Q930	F-13
Q50	F-4	Q999	I-10
Q51	F-4		

Note:

- Color code or sleeving over the end of the jacket.

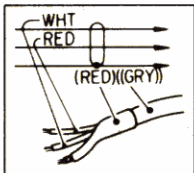

- : parts extracted from the component side.
- : parts extracted from the conductor side.
- CAN: Canadian
- WG: West Germany
- ※1 Including CONTROL BOARD
- ※2 Including Y/C BOARD

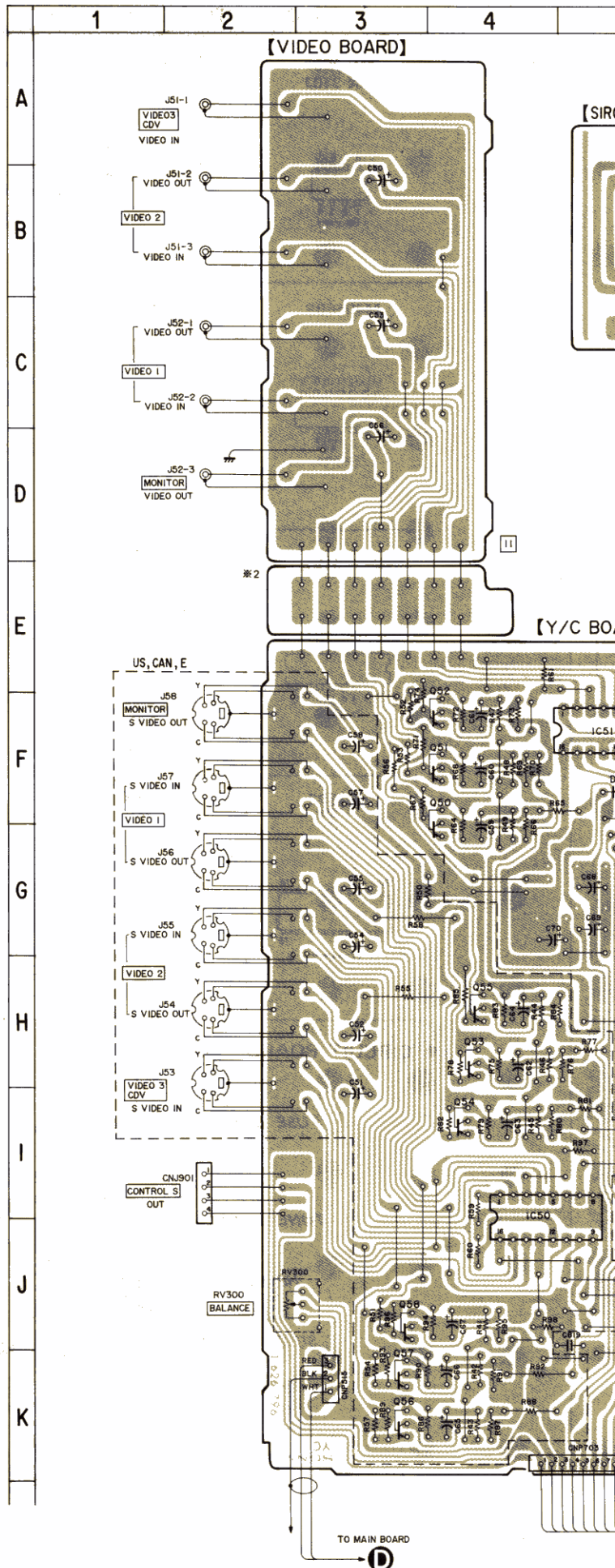

D]

[SIRCS BOARD]

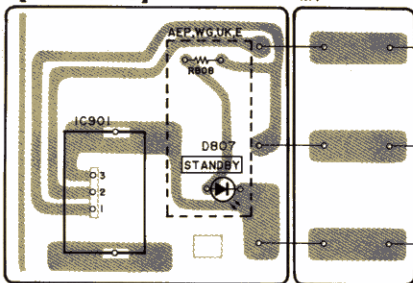

[CONTROL BOARD]

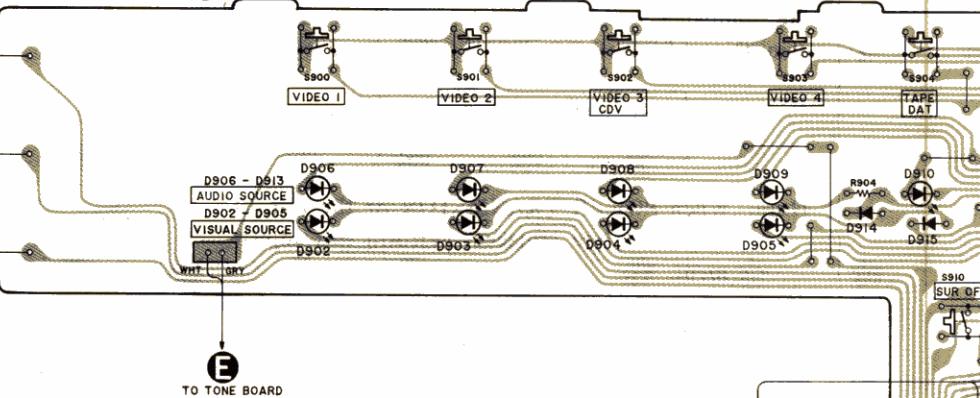

[Y/C BOARD]

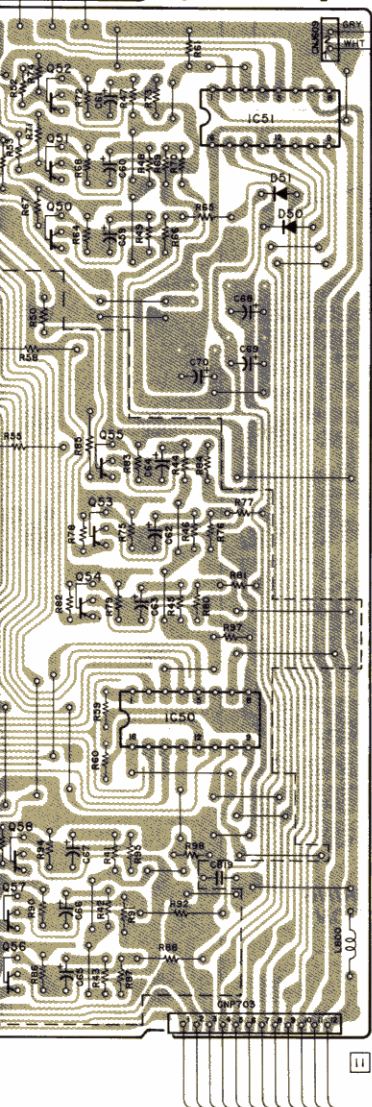

[MICOM BOARD]

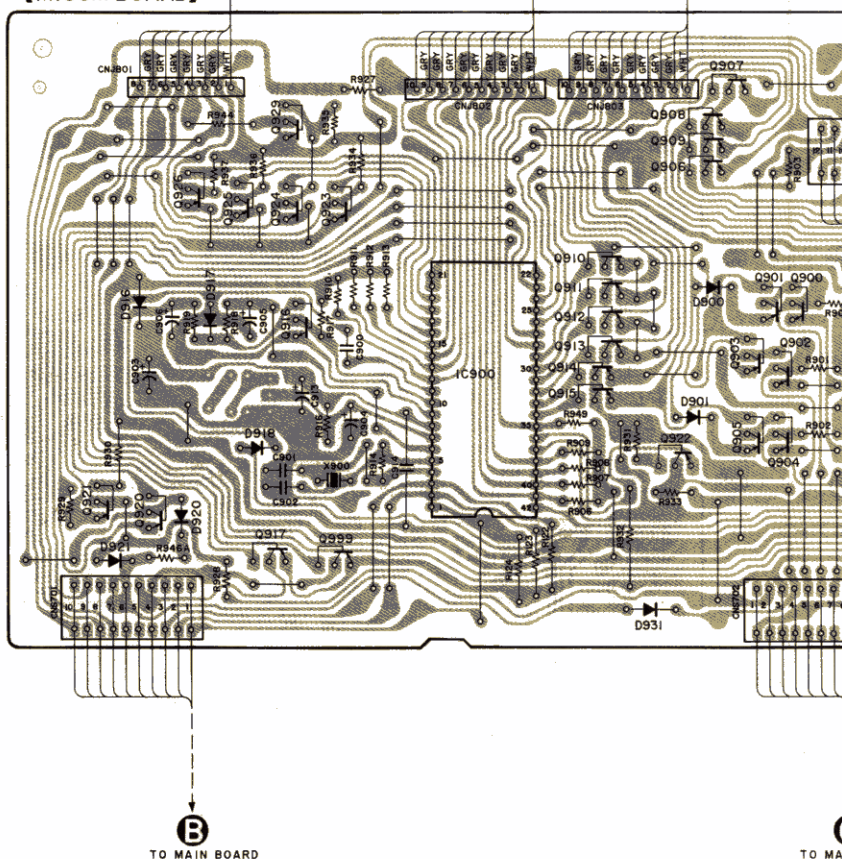

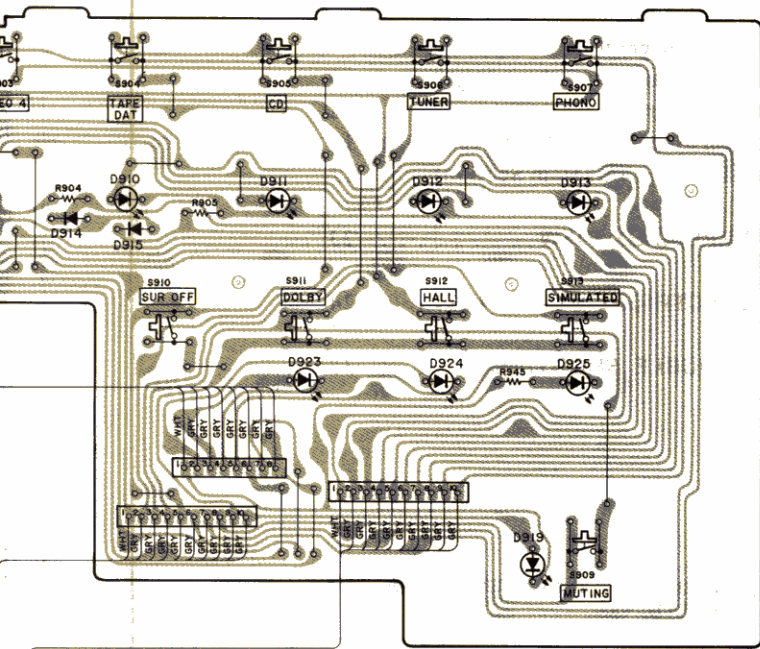

II

F
TO FUSE BOARD

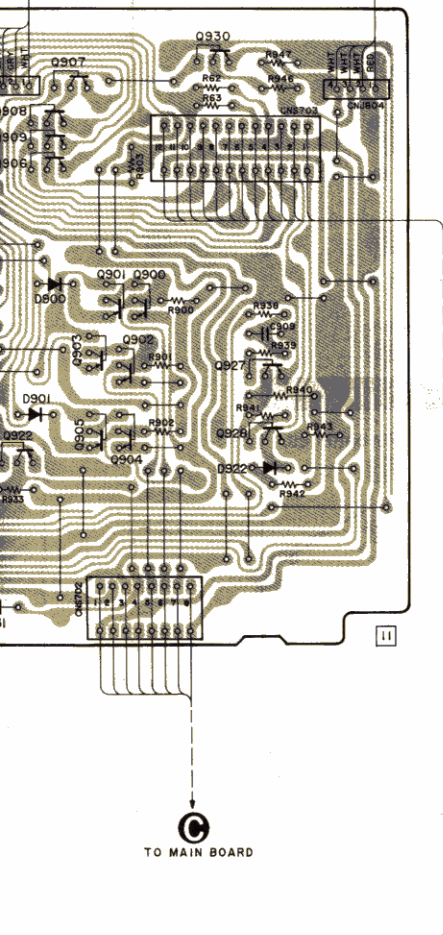

C
TO MAIN BOARD

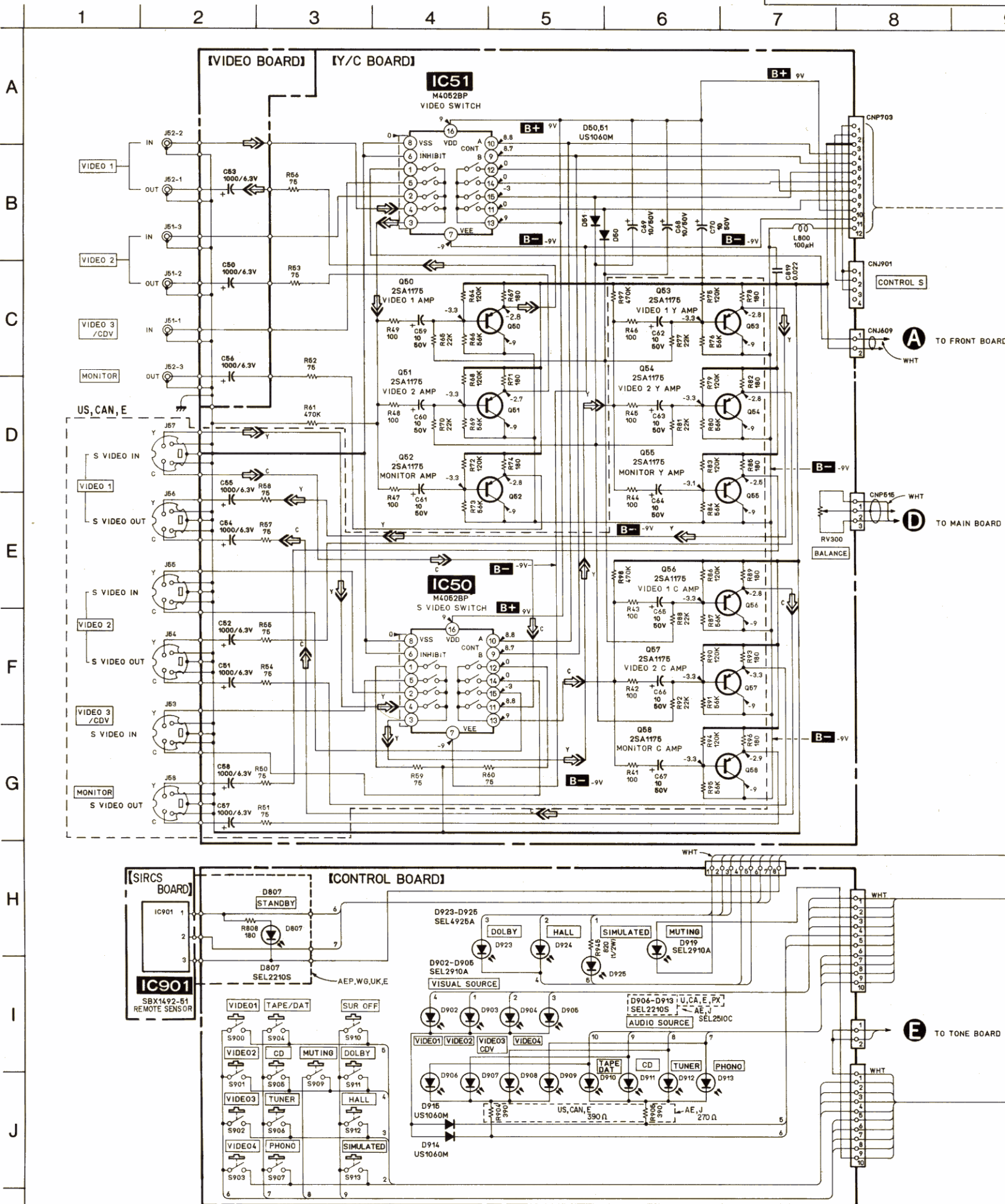

[MICOM BOARD]

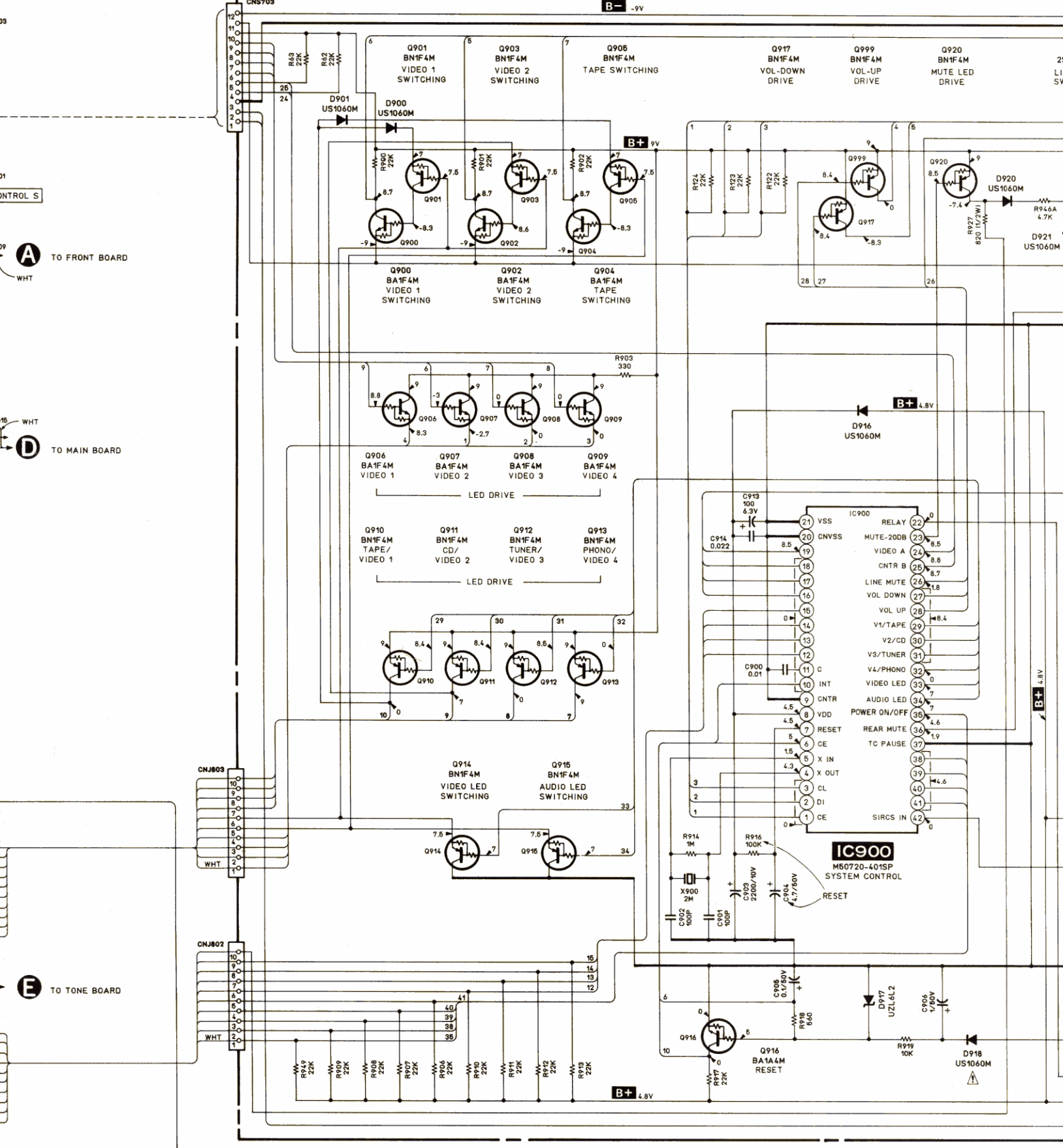

CONTROL S

A TO FRONT BOARD

D TO MAIN BOARD

E TO TONE BOARD

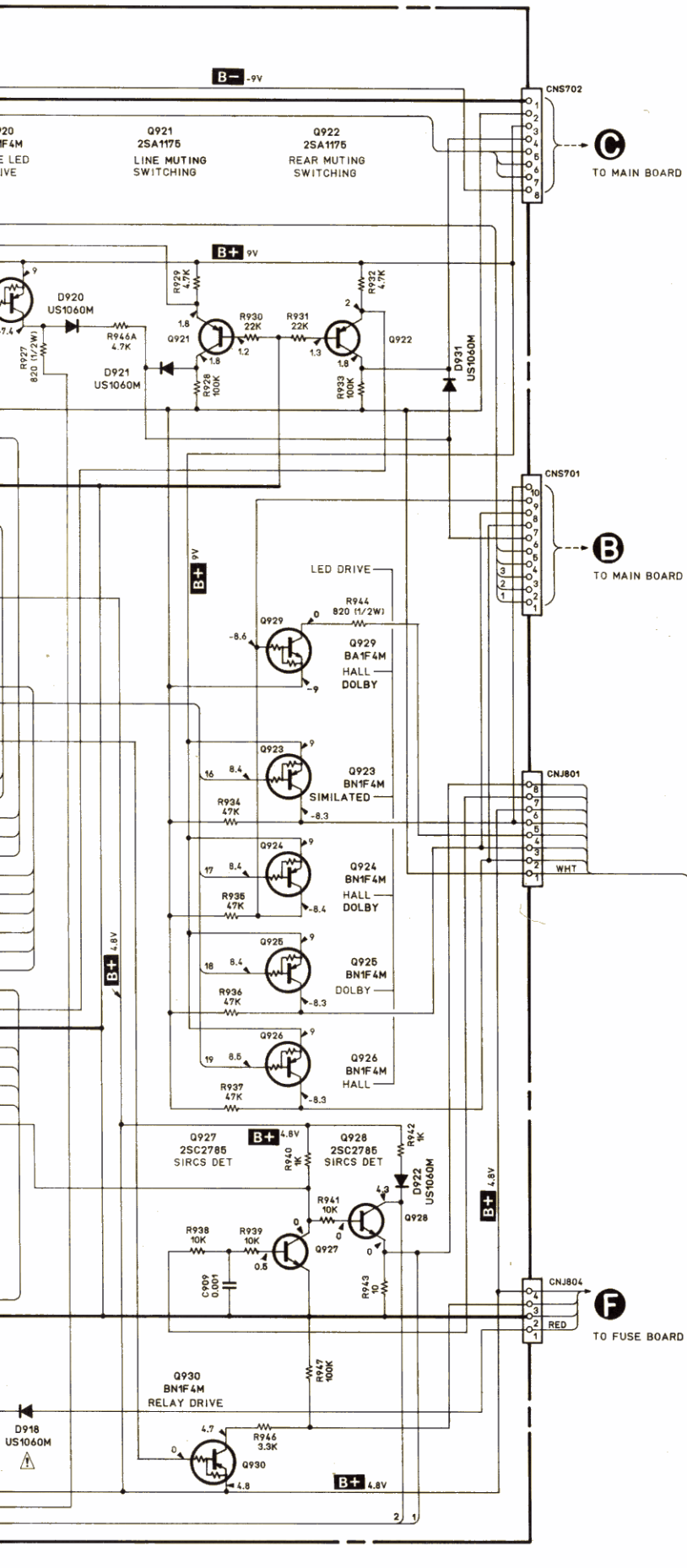

Note:

- All capacitors are in μF unless otherwise noted. pF : μmF 50VV or less are not indicated except for electrolytics and tantalums.
- All resistors are in Ω and $1/4\text{W}$ or less unless otherwise specified.
- Voltage and waveforms are dc with respect to ground under no-signal conditions.
- Voltages are taken with a VOM (50 $\text{k}\Omega/\text{V}$). Voltage variations may be noted due to normal production tolerances.
- Signal path.
- Switches:

Ref. No.	Switch	Position
S900	VIDEO 1	OFF
S901	VIDEO 2	OFF
S902	VIDEO 3	OFF
S903	VIDEO 4	OFF
S904	TAPE/DAT	OFF
S905	CD	OFF
S906	TUNER	OFF
S907	PHONO	OFF
S908	SYSTEM POWER	OFF
S909	MUTING	OFF
S910	SUR OFF	OFF
S911	DOLBY	OFF
S912	HALL	OFF
S913	SIMULATE	OFF

- CAN: Canadian
- WG: West Germany

<p>Note: The components identified by mark \triangle or dotted line with mark \triangle are critical for safety. Replace only with part number specified.</p>	<p>Note: Les composants identifiés par une marque \triangle sont critiques pour la sécurité. Ne les remplacer que par une pièce portant le numéro spécifié.</p>
--	---

3-4. IC BLOCK DIAGRAM

A
B
C
D
E
F
G
H
I
J

IC101
LC7822

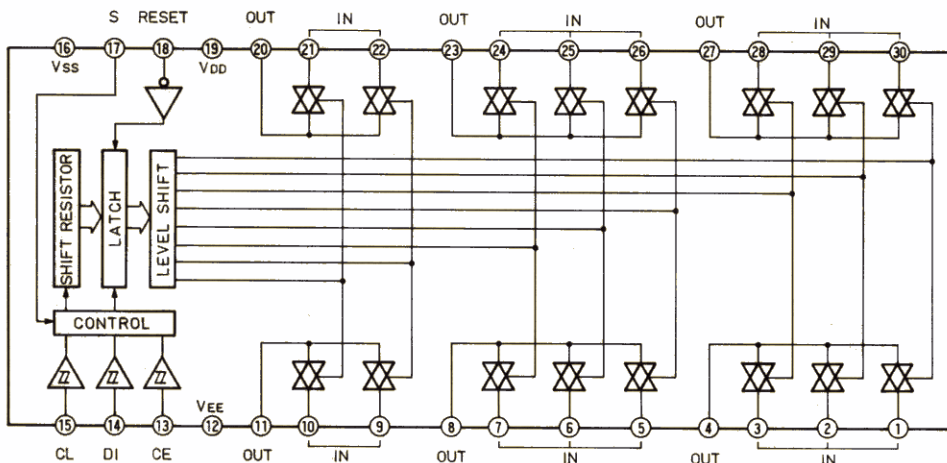

IC452
MN3007

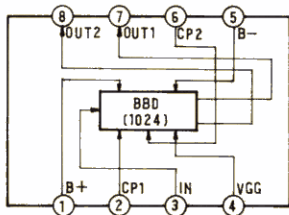

IC453
MN3101

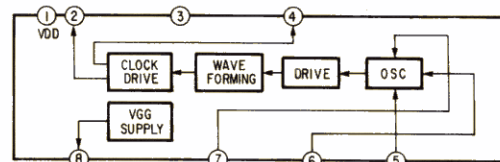

IC455
NE646N

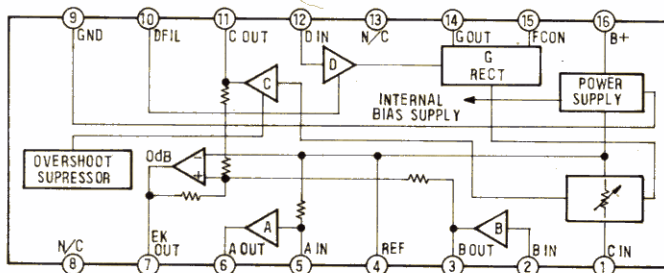

IC700
STK4026

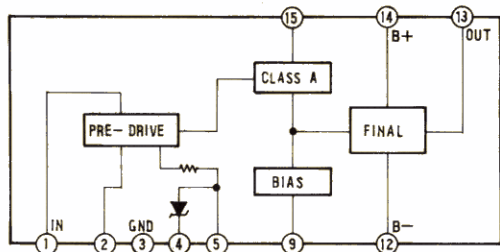

IC701
μPC1237HA

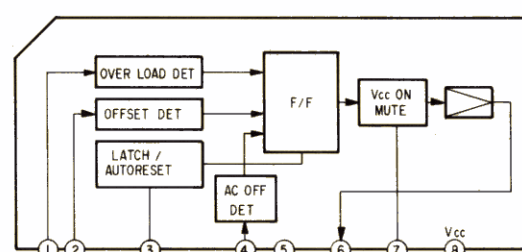

3-5. PRINTED WIRING BOARDS

—Main Section—

● Semiconductor Location (Main)

Ref. No.	Location	Ref. No.	Location
D502	C-13	Q500	D-12
D503	C-13	Q501	D-12
D504	C-13	Q502	D-12
D601	D-4	Q503	D-12
D602	D-6	Q504	D-11
D603	E-7	Q505	C-10
D604	E-6	Q506	B-11
D700	E-11	Q507	C-12
D701	E-10	Q508	C-10
D702	E-10	Q509	C-12
D703	G-25	Q510	B-10
D704	H-26	Q511	C-12
D729	E-15	Q512	B-12
D800	D-9	Q513	B-12
D801	D-9	Q514	B-13
D802	F-11	Q600	D-5
D803	F-10	Q601	D-5
D804	B-16	Q602	D-5
D805	E-14	Q603	D-5
D806	E-16	Q604	D-4
D929	E-15	Q605	C-4
D930	F-15	Q606	A-6
—	—	Q607	C-7
IC100	I-4	Q608	C-4
IC101	I-6	Q609	C-7
IC102	G-5	Q610	B-5
IC202	F-4	Q611	B-6
IC300	I-9	Q612	B-4
IC301	E-6	Q613	B-4
IC302	G-7	Q614	D-6
IC303	C-26	Q700	G-26
IC450	G-9	Q701	E-10
IC451	I-10	Q702	G-13
IC452	I-11	Q703	H-26
IC453	I-12	Q704	H-25
IC454	G-10	Q705	G-13
IC455	G-11	Q800	E-9
IC700	G-25	Q801	F-8
IC701	E-11	Q802	E-16
IC800	F-9	Q918	H-7
IC801	E-9	Q919	H-7
IC802	F-9	Q931	E-15
IC803	E-15	Q998	H-8

Note:

- Color code or sleeving over the end of the jacket.

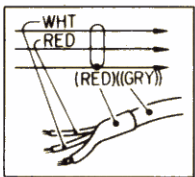

- — : parts extracted from the component side.
- — : parts extracted from the conductor side.
- CAN: Canadian
- WG: West Germany

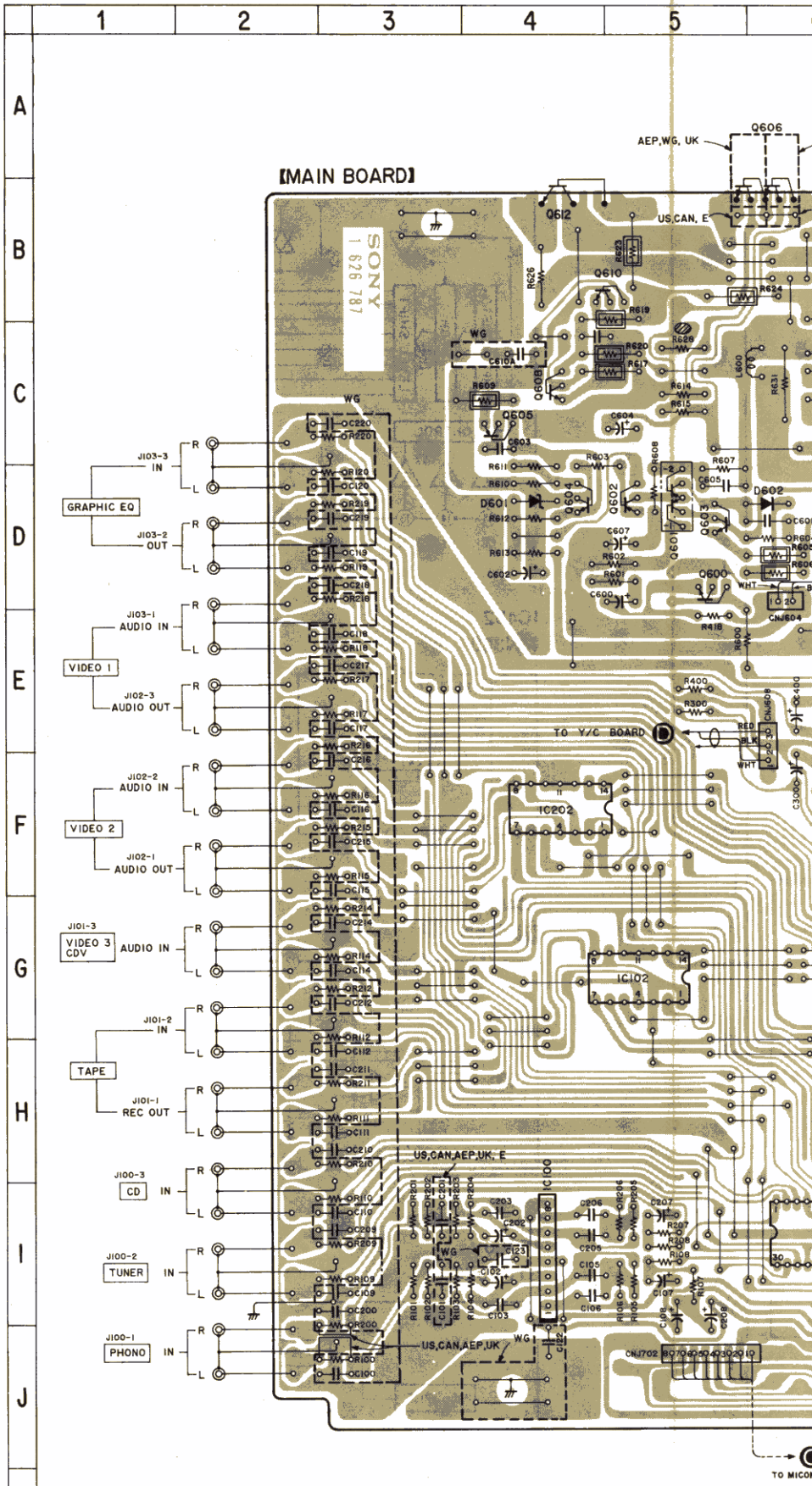

5 6 7 8 9 10 11 12 13

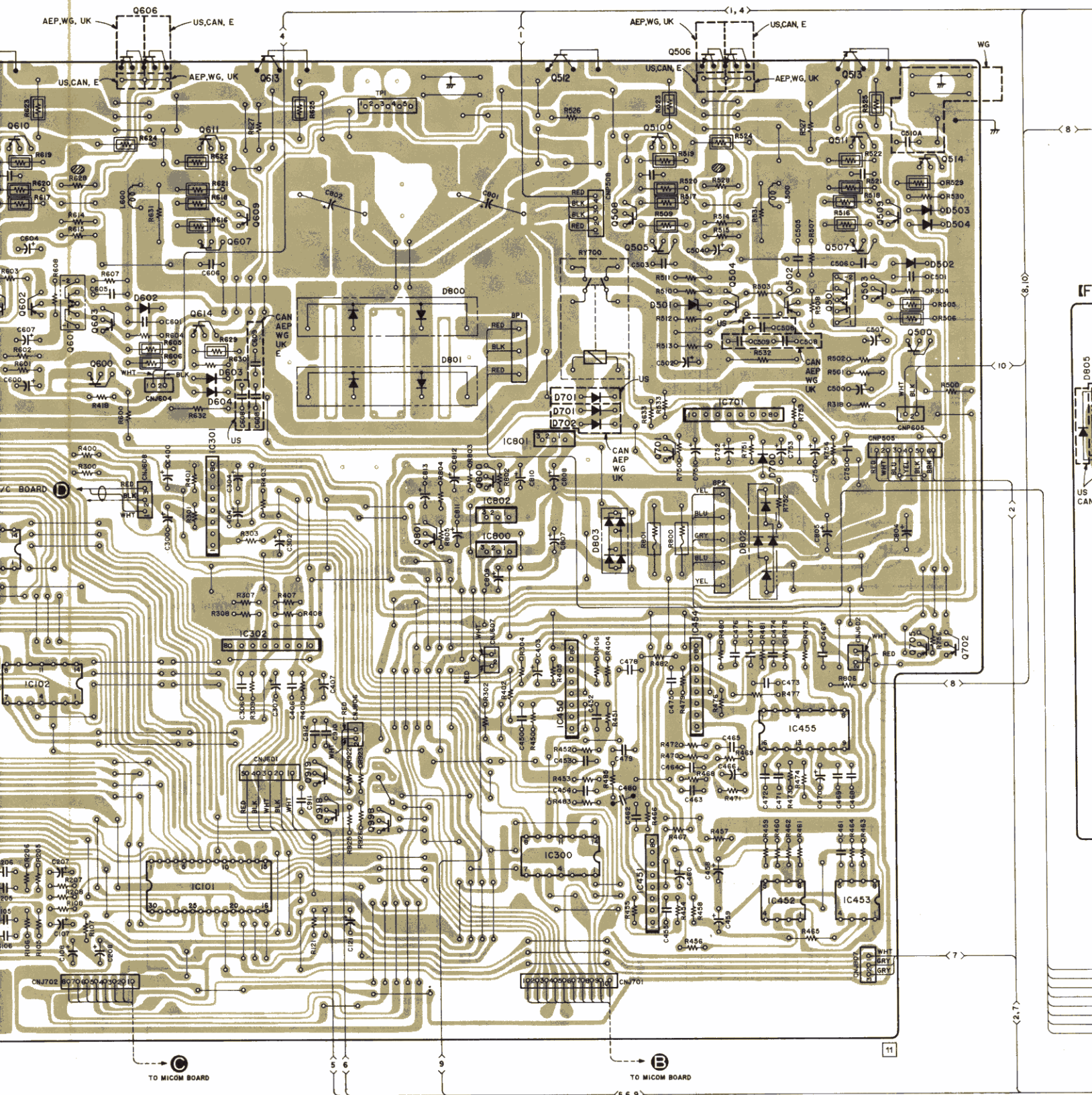

14

15

16

17

18

19

20

21

22

<1,4,10>

[VOL IND BOARD]

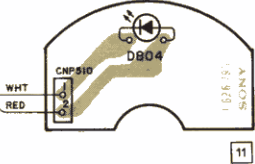

[VOL BOARD]

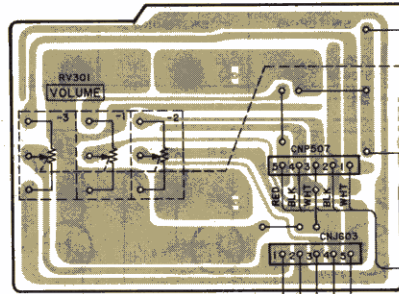

[MOTOR BOARD]

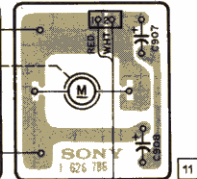

[TONE BOARD]

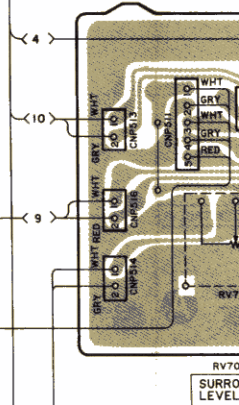

[FUSE BOARD]

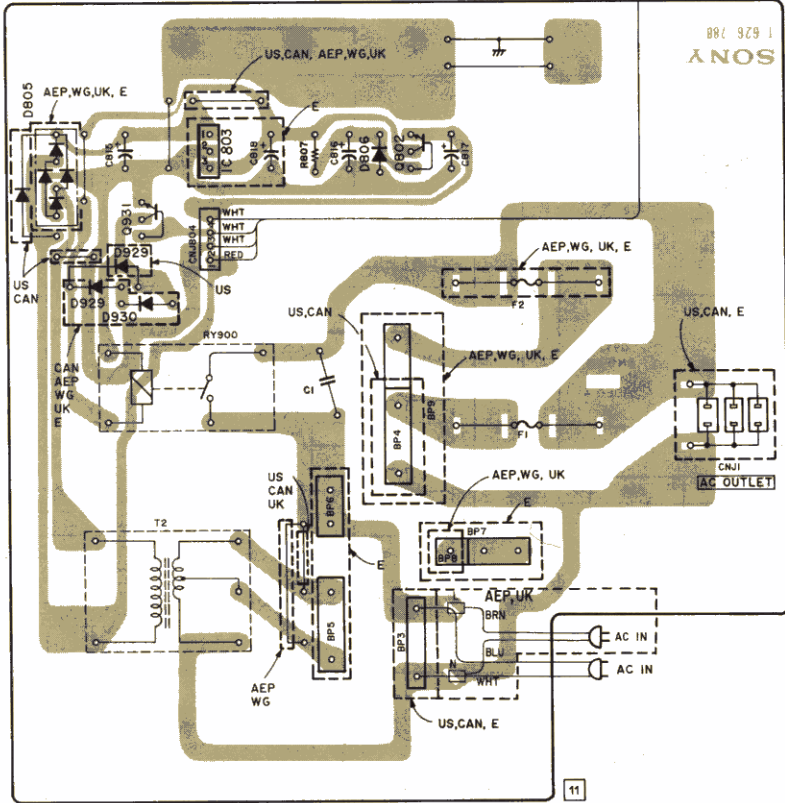

TO MICON BOARD

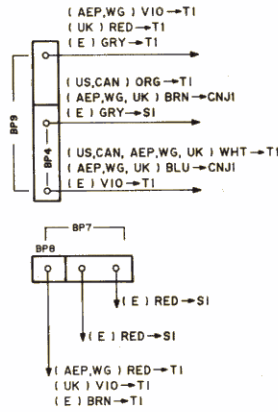
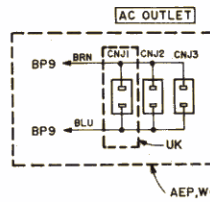

[FRONT BOARD]

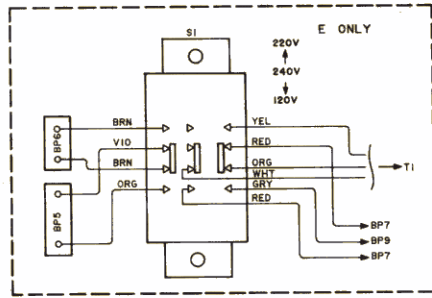
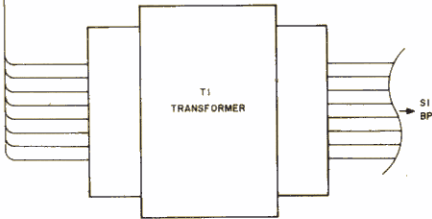
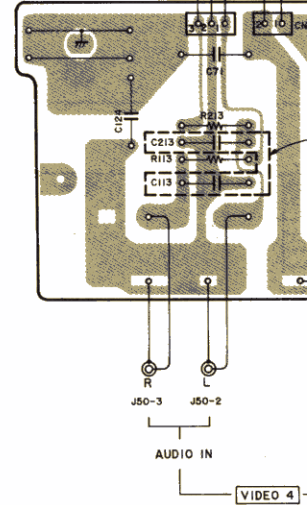

<2,5,6,7,9>

3-6. SCHEMATIC DIAGRAM

-Main Section-

[MAIN BOARD]

[FRONT BOARD]

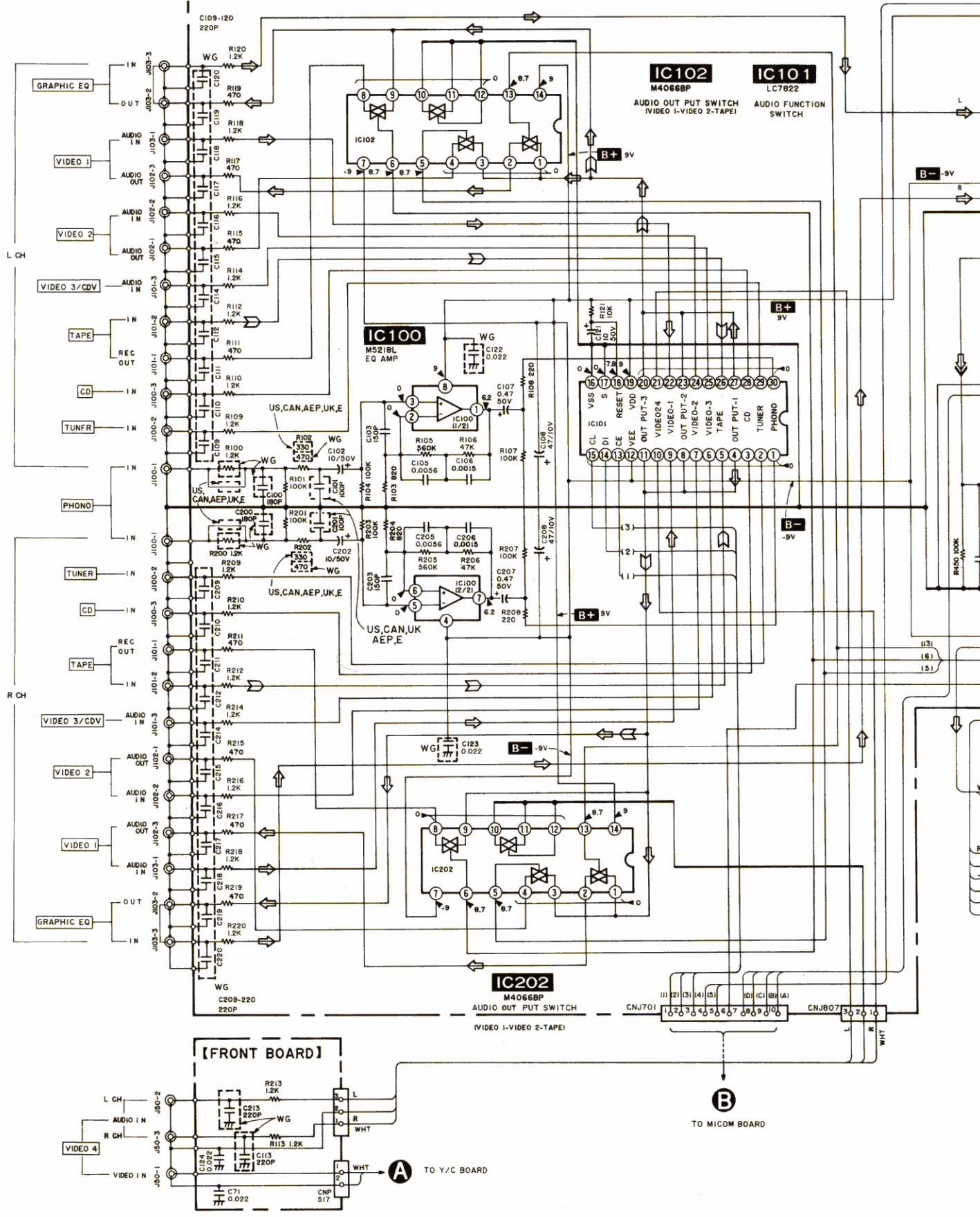

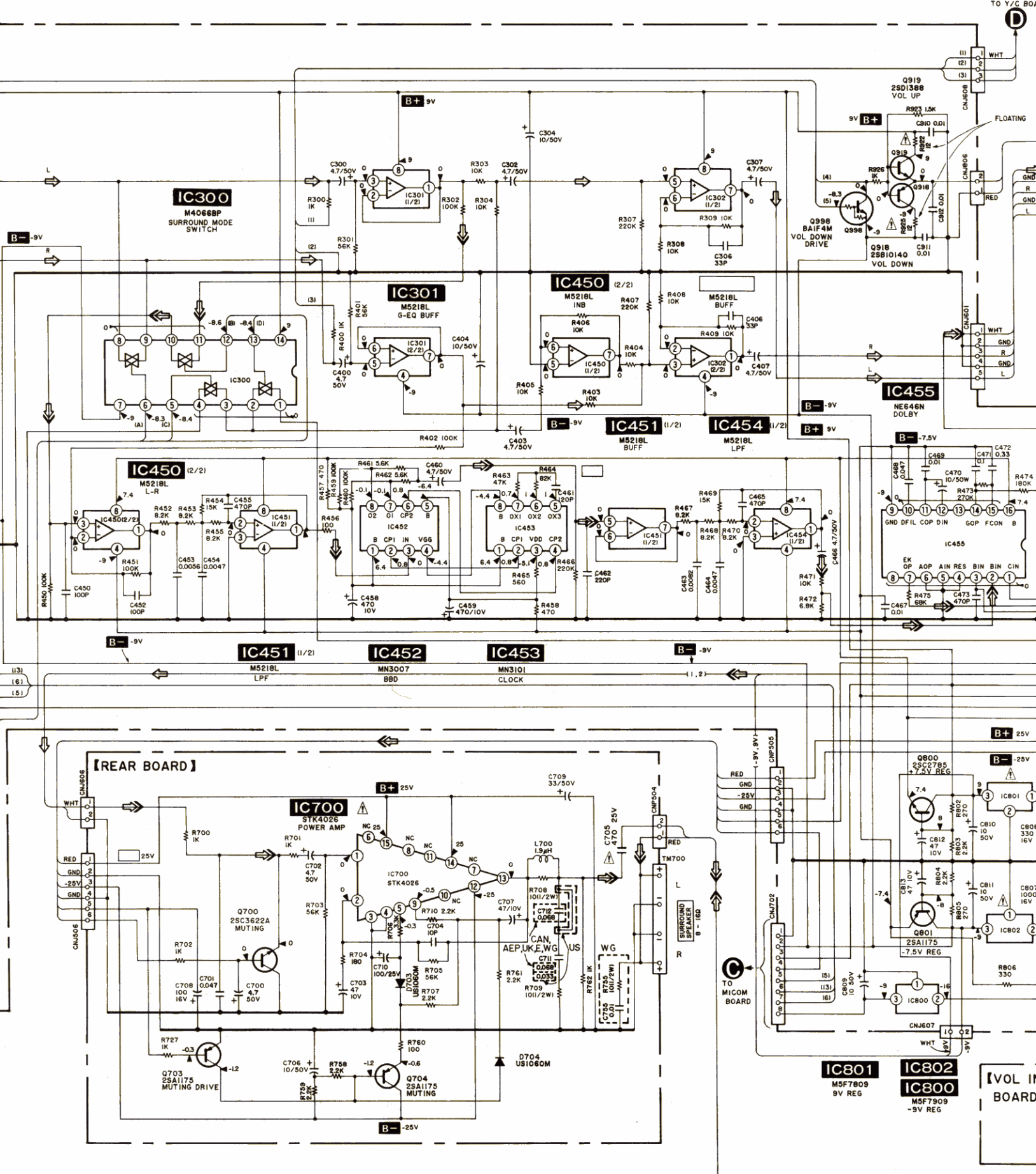

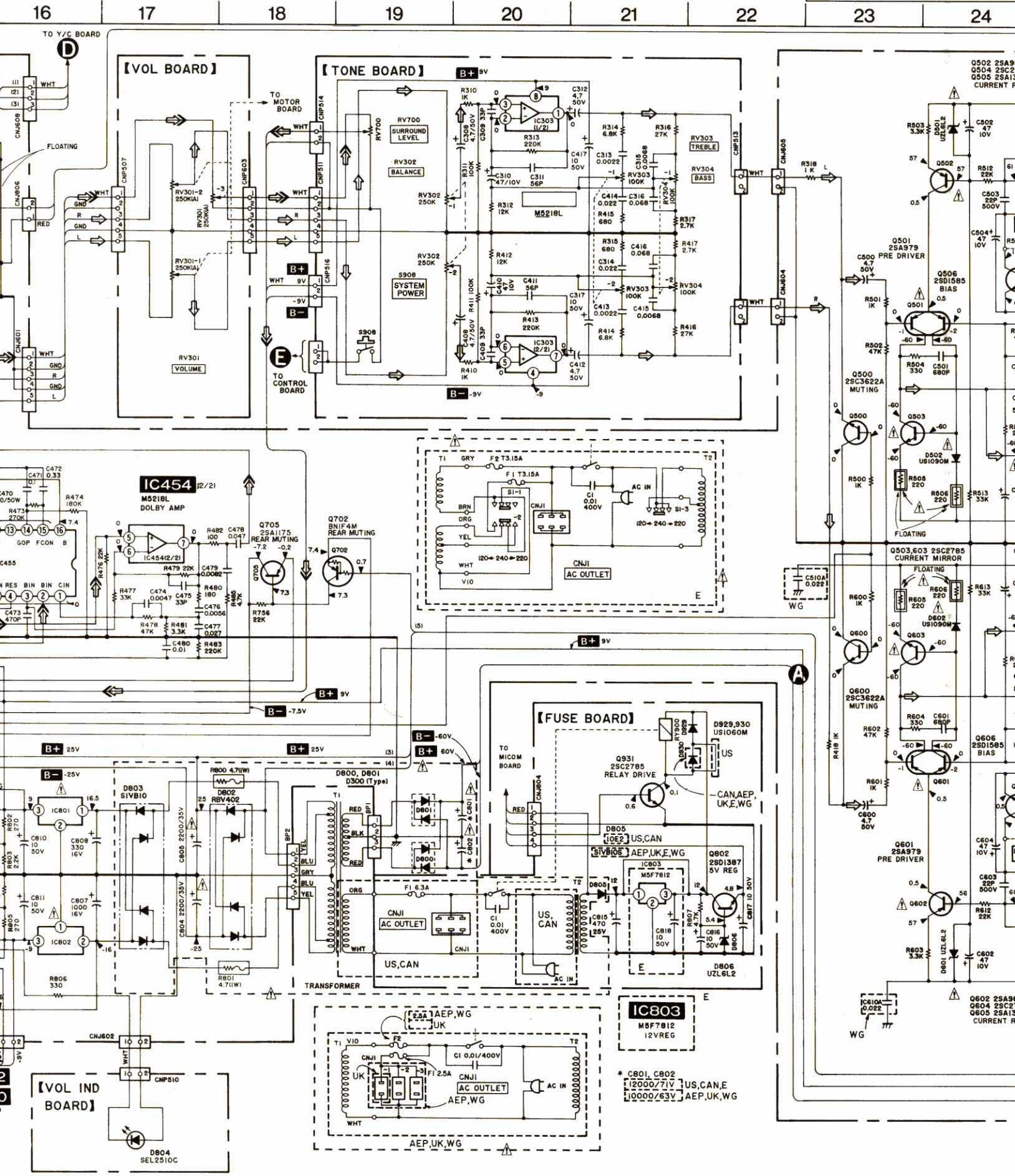

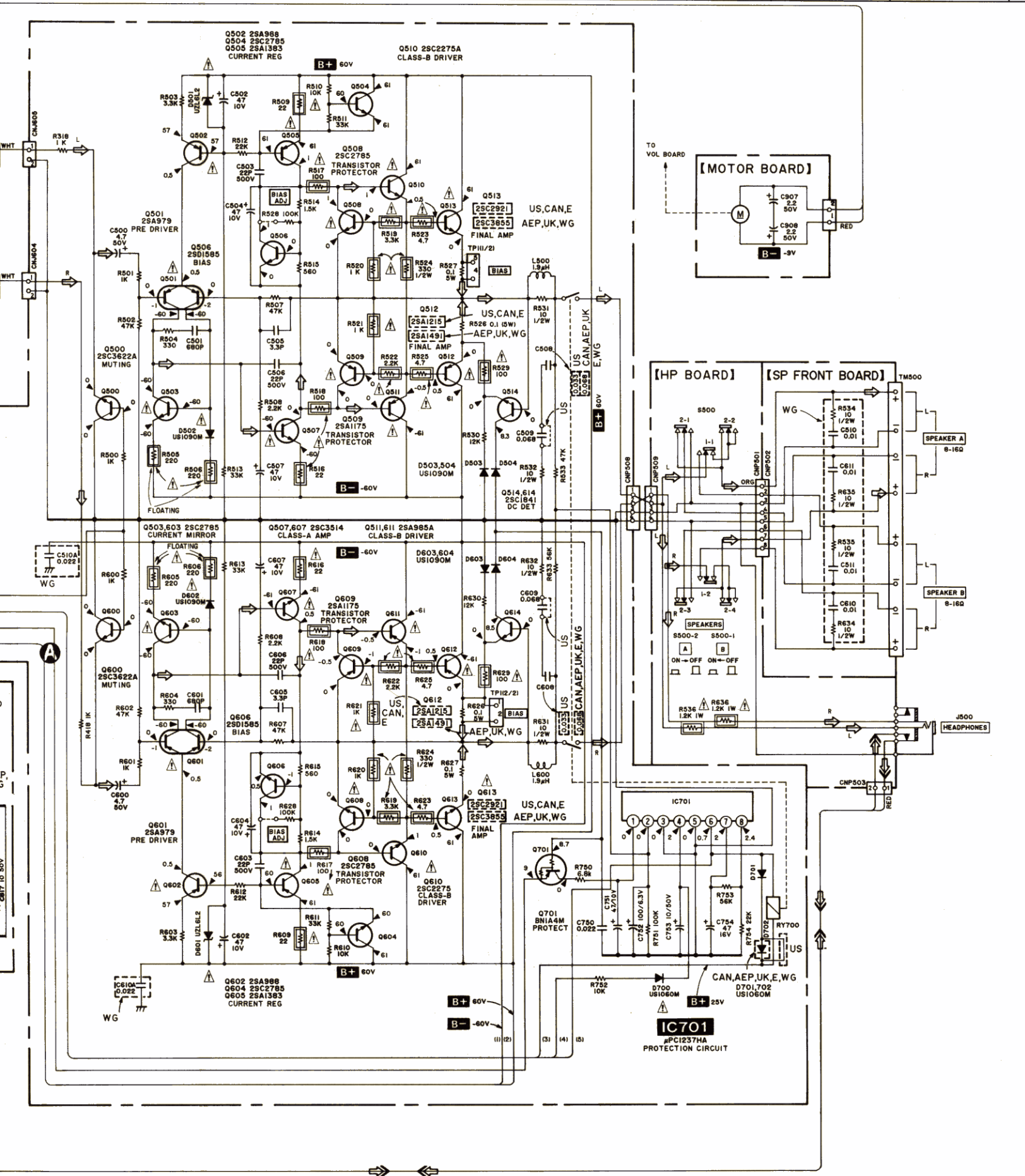

A

B

C

D

E

F

G

H

I

J

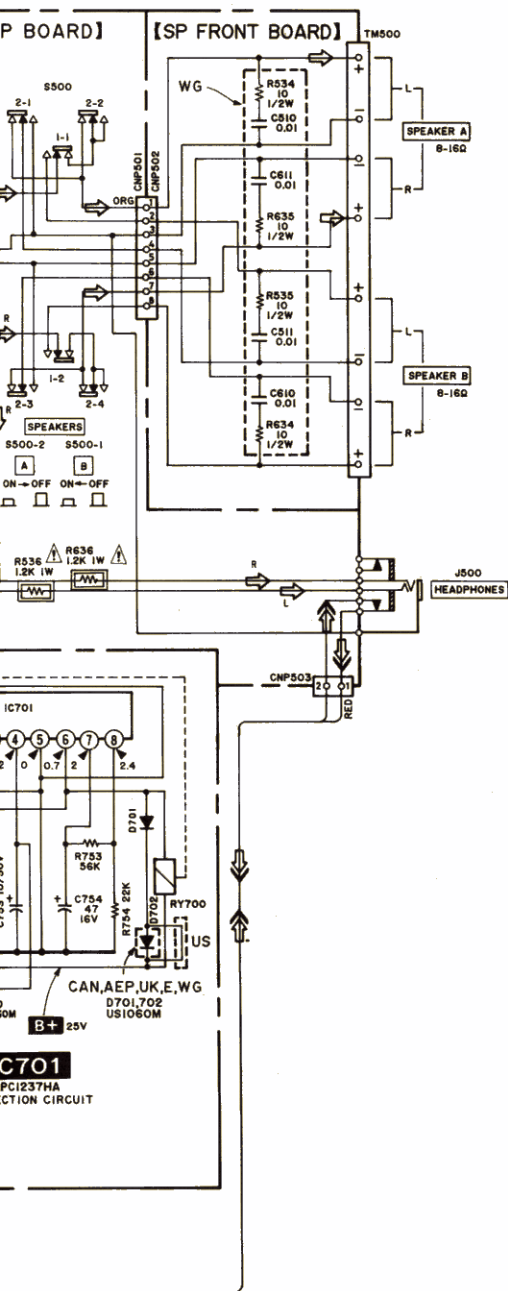
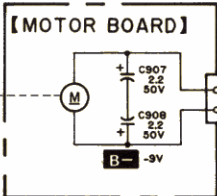

Note:

- All capacitors are in μF unless otherwise noted. pF : $\mu\mu\text{F}$ 50WV or less are not indicated except for electrolytics and tantalums.
- All resistors are in Ω and $1/4\text{W}$ or less unless otherwise specified.
- : nonflammable resistor.
- : fusible resistor.
- : adjustment for repair.
- Voltage and waveforms are dc with respect to ground under no-signal conditions.
- Voltages are taken with a VOM (50 $\text{k}\Omega/\text{V}$). Voltage variations may be noted due to normal production tolerances.
- Signal path.
 - : VIDEO SOUND signal path.
 - : SURROUND signal path.
 - : AUDIO TAPE P-B signal path.
- Switches:

Ref. No.	Switch	Position
S1	VOLTAGE SELECTOR	240V
S500-1	SPEAKERS B	OFF
S500-2	SPEAKERS A	ON
S908	SYSTEM POWER	OFF

- CAN: Canadian
- WG: West Germany



Note:
The components identified by mark or dotted line with mark are critical for safety. Replace only with part number specified.

Note:
Les composants identifiés par une marque sont critiques pour la sécurité. Ne les remplacer que par une pièce portant le numéro spécifié.

NOTE:

- The mechanical parts with no reference number in the exploded views are not supplied.
- The construction parts of an assembled part are indicated with a collation number in the remark column.
- Items marked "★" are not stocked since they are seldom required for routine service. Some delay should be anticipated when ordering these items.

- Due to standardization, parts with part number suffix -XX and -X may be different from the parts specified in the components used on the set.
- Color Indication of Appearance Parts
Example:
(RED) ... KNOB, BALANCE (WHITE)
↑ Cabinet's Color ↑ Parts' Color

The components identified by mark  or dotted line with mark  are critical for safety. Replace only with part number specified.

Les composants identifiés par une marque  sont critiques pour la sécurité. Ne les remplacer que par une pièce portant le numéro spécifié.

1. GENERAL

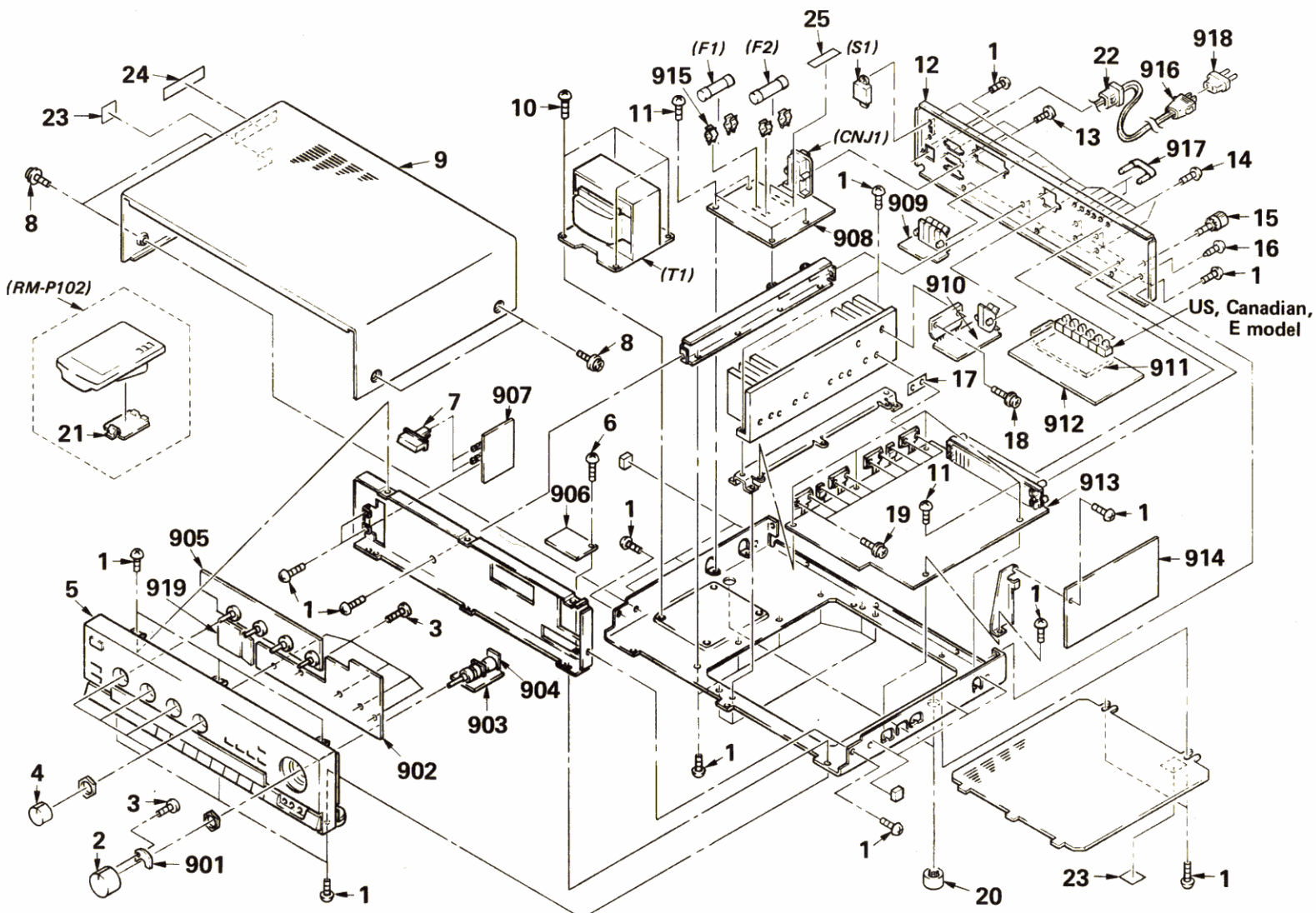

SECTION 4 EXPLODED VIEWS

Parts with part
may be dif-
fied in the
Parts
Parts' Color

The components identified by
mark or dotted line with mark
 are critical for safety.
Replace only with part number
specified.

Les composants identifiés par une
marque sont critiques pour la
sécurité.
Ne les remplacer que par une
pièce portant le numéro spécifié.

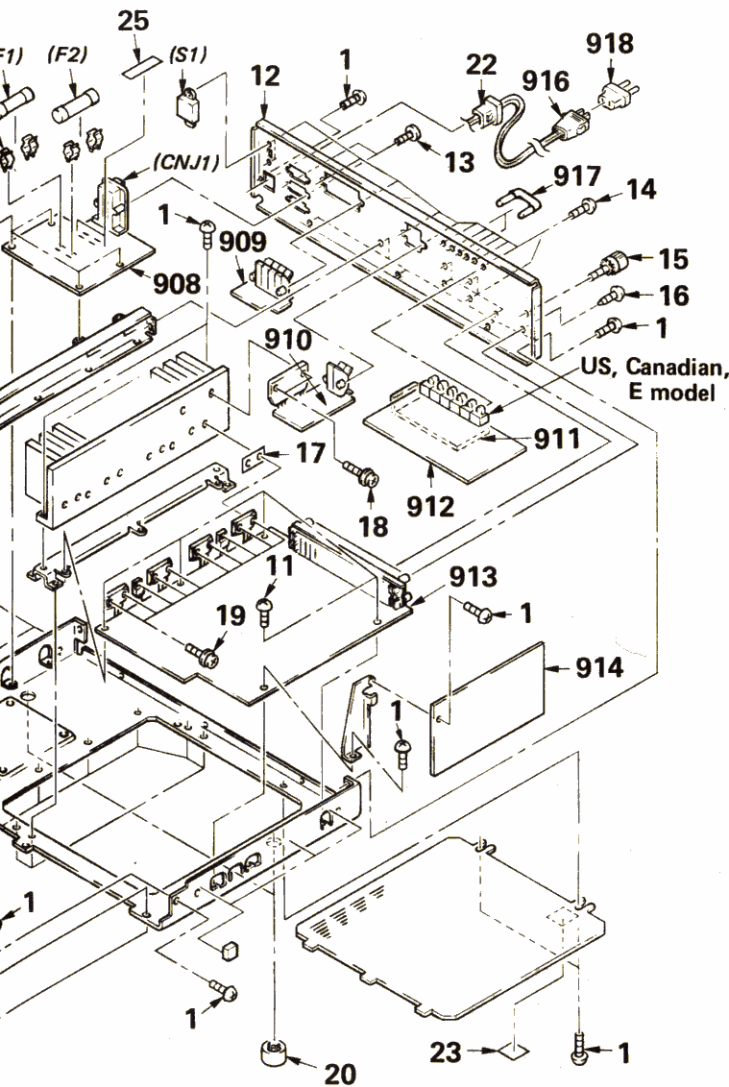

No.	Part No.	Description	Remarks
1	7-682-548-04	SCREW +BVTT 3X8 (S)	
2	4-925-121-01	KNOB (V2)	
3	7-685-534-19	SCREW +BTP 2.6X8 TYPE2 N-S	
4	4-916-746-01	KNOB (DIA.21)	
5	X-4904-488-1	PANEL ASSY, FRONT	
6	7-682-147-01	SCREW +BVTT 3X6 (S)	
7	4-924-901-01	BUTTON (M)	
8	3-704-366-01	SCREW (CASE) (M3X8)	
9	4-925-039-11	CASE	
10	7-682-560-04	SCREW +BVTT 4X6 (S)	
11	7-682-548-04	SCREW, TOTSU PTTWH 3X8	
12	*4-921-343-11	(Canadian)...PANEL, BACK	
	*4-921-343-21	(AEP)...PANEL, BACK	
	*4-921-343-41	(WG)...PANEL, BACK	
	*4-921-343-51	(UK)...PANEL, BACK	
	*4-921-343-61	(E)...PANEL, BACK	
13	7-685-646-79	SCREW +BTP 3X8 TYPE2 N-S	
14	7-685-646-79	SCREW +BVTP 3X8 TYPE2 N-S	
15	*3-706-165-00	SCREW	
16	4-909-982-01	SCREW, TAPPING	
17	4-885-901-31	(US,Canadian,E)...SHEET, RADIATION	
	4-911-232-01	(AEP,UK,WG)...SHEET, INSULATING	
18	7-682-550-04	SCREW (M3X12), TAPPING	
19	4-925-027-11	SCREW (M3X16), TAPPING	
20	X-4864-303-0	FOOT ASSY	
21	4-922-048-01	COVER, BATTERY	
22	3-703-244-02	(US,Canadian,AEP,UK,WG) ...BUSHING (2104), CORD	
	3-703-571-11	(E)...BUSHING (S) (4516), CORD	
23	3-703-680-02	(US)...LABEL, CAUTION, SUB, NEW UL	
24	4-915-702-01	LABEL, CAUTION, DOLBY SURROUND	
25	3-701-947-16	(E,UK)...LABEL, FUSE	
	3-701-948-01	(AEP,WG)...LABEL, FUSE	
901	*1-626-790-11	PC BOARD, VOL IND	
902	*1-626-792-11	PC BOARD, CONT	
903	*1-626-785-11	PC BOARD, VOL	
904	*1-626-786-11	PC BOARD, MOTOR	
905	*1-626-791-11	PC BOARD, TONE	
906	*1-626-789-11	PC BOARD, FRONT	
907	*1-626-784-11	PC BOARD, HP	
908	*1-626-788-11	PC BOARD, FUSE	
909	*1-626-783-11	PC BOARD, SP FRONT	
910	*1-626-782-11	PC BOARD, REAR (B)	
911	*1-626-793-11	PC BOARD, VIDEO	
912	*A-4410-819-A	(US,Canadian)...MOUNTED PCB, Y/C	
913	*A-4388-752-A	(US)...MOUNTED PCB, MAIN	
	*A-4388-753-A	(Canadian,E)...MOUNTED PCB, MAIN	
	*A-4388-754-A	(WG)...MOUNTED PCB, MAIN	
	*A-4388-759-A	(AEP,UK)...MOUNTED PCB, MAIN	
914	*A-4410-780-A	MOUNTED PCB, MICOM	
915	1-533-183-11	(AEP,UK,E,WG)...HOLDER, FUSE	
916	1-551-188-XX	(E)...CORD, POWER	
	1-558-944-11	(AEP,WG)...CORD, POWER	
	1-558-946-11	(UK)...CORD, POWER	
	1-559-819-11	(US,Canadian)...CORD, POWER	
917	1-535-706-11	PLUG, JUMPER	
918	1-526-565-00	AC PLUG ADAPTOR	
919	*1-626-795-11	PC BOARD, SIRCS	
CNJ1	1-526-794-11	(AEP,WG)...OUTLET, AC	
CNJ1	1-526-751-11	(UK)...OUTLET, AC	
CNJ1	1-540-012-11	(US,Canadian,E)...OUTLET, AC	
F1	1-532-237-00	(AEP,UK,E,WG)...FUSE, TIME-LAG (3.15A)	
F1	1-532-748-00	(US,Canadian)...FUSE (6.3A)	
F2	1-532-237-00	(E)...FUSE, TIME-LAG (3.15A)	
F2	1-532-286-00	(AEP,UK,WG)...FUSE, TIME-LAG (2.15A)	
S1	1-571-515-11	(E)...VOLTAGE SELECTOR	
T1	1-449-265-11	(US,Canadian)...TRANSFORMER, POWER	
T1	1-449-300-11	(AEP,UK,WG)...TRANSFORMER, POWER	
T1	1-449-301-11	(E)...TRANSFORMER, POWER	

NOTE:

- Due to stan-
list may be
the diagram
- Items mar-
are seldom
delay shou-
items.
- If there ar-
such as a
circuit part
resistors in-

Ref.No. **Part**

901	*1-626-790-11
902	*1-626-792-11
903	*1-626-785-11
904	*1-626-786-11
905	*1-626-791-11
906	*1-626-789-11
907	*1-626-784-11
908	*1-626-788-11
909	*1-626-783-11
910	*1-626-782-11
911	*1-626-793-11
912	*A-4410-819-A
913	*A-4388-752-A
	*A-4388-753-A
	*A-4388-754-A
	*A-4388-759-A
914	*A-4410-780-A
915	1-533-183-11
916	1-551-188-XX
	1-558-944-11
	1-558-946-11
	1-559-819-11
917	1-535-706-11
918	1-526-565-00
919	*1-626-795-11
BP1	*1-626-794-11
BP2	*1-626-751-11
BP3	*1-626-012-11
BP4	*1-533-183-11
BP5	*1-551-188-XX
BP6	*1-558-944-11
BP7	*1-558-946-11
BP8	*1-559-819-11
BP9	*1-535-706-11
C1	1-533-183-11
C50	1-124-188-XX
C51	1-124-944-11
C52	1-124-946-11
C53	1-124-535-706-11
C54	1-124-526-794-11
C55	1-124-526-751-11

SECTION 5 ELECTRICAL PARTS LIST

NOTE:

- Due to standardization, replacements in the parts list may be different from the parts specified in the diagrams or the components used on the set.
- Items marked "*" are not stocked since they are seldom required for routine service. Some delay should be anticipated when ordering these items.
- If there are two or more same circuits in a set such as a stereophonic machine, only typical circuit parts may be indicated and capacitors and resistors in other same circuits may be omitted.

CAPACITORS:

MF: μ F, PF: μ PF.

RESISTORS

- All resistors are in ohms.
- F: nonflammable

COILS

- MMH: mH, UH: μ H

SEMICONDUCTORS

In each case, U: μ , for example:
 UA...: μ A..., UPA...: μ PA...,
 UPC...: μ PC, UPD...: μ PD...

The components identified by mark Δ or dotted line with mark Δ are critical for safety. Replace only with part number specified.

Les composants identifiés par une marque Δ sont critiques pour la sécurité. Ne les remplacer que par une pièce portant le numéro spécifié.

Ref.No.	Part No.	Description	Ref.No.	Part No.	Description
901	*1-626-790-11	PC BOARD, VOL IND	C56	1-124-471-00	ELECT 1000MF 20% 6.3V
902	*1-626-792-11	PC BOARD, CONT	C57	1-124-471-00	(US,Canadian,E) ...ELECT 1000MF 20% 6.3V
903	*1-626-785-11	PC BOARD, VOL	C58	1-124-471-00	(US,Canadian,E) ...ELECT 1000MF 20% 6.3V
904	*1-626-786-11	PC BOARD, MOTOR	C59	1-123-875-11	ELECT 10MF 20% 50V
905	*1-626-791-11	PC BOARD, TONE	C60	1-123-875-11	ELECT 10MF 20% 50V
906	*1-626-789-11	PC BOARD, FRONT	C61	1-123-875-11	ELECT 10MF 20% 50V
907	*1-626-784-11	PC BOARD, HP	C62	1-123-875-11	(US,Canadian,E)..ELECT 10MF 20% 50V
908	*1-626-788-11	PC BOARD, FUSE	C63	1-123-875-11	(US,Canadian,E)..ELECT 10MF 20% 50V
909	*1-626-783-11	PC BOARD, SP FRONT	C64	1-123-875-11	(US,Canadian,E)..ELECT 10MF 20% 50V
910	*1-626-782-11	PC BOARD, REAR (B)	C65	1-123-875-11	(US,Canadian,E)..ELECT 10MF 20% 50V
911	*1-626-793-11	PC BOARD, VIDEO	C66	1-123-875-11	(US,Canadian,E)..ELECT 10MF 20% 50V
912	*A-4410-819-A	(US,Canadian)...MOUNTED PCB, Y/C	C67	1-123-875-11	(US,Canadian,E)..ELECT 10MF 20% 50V
913	*A-4388-752-A	(US).....MOUNTED PCB, MAIN	C68	1-123-875-11	ELECT 10MF 20% 50V
	*A-4388-753-A	(Canadian,E)...MOUNTED PCB, MAIN	C69	1-123-875-11	ELECT 10MF 20% 50V
	*A-4388-754-A	(WG).....MOUNTED PCB, MAIN	C70	1-123-875-11	ELECT 10MF 20% 50V
	*A-4388-759-A	(AEP,UK).....MOUNTED PCB, MAIN	C71	1-161-494-00	CERAMIC 0.022MF 30% 25V
914	*A-4410-780-A	MOUNTED PCB, MICOM	C100	1-162-285-31	(WG)...CERAMIC 180PF 10% 50V
915	Δ 1-533-183-11	(AEP,UK,E,WG)...HOLDER, FUSE	C101	1-162-282-31	(US,Canadian,AEP,UK,E) ...CERAMIC 100PF 10% 50V
916	Δ 1-551-188-XX	(E).....CORD, POWER	C102	1-123-875-11	ELECT 10MF 20% 50V
	Δ 1-558-944-11	(AEP,WG).....CORD, POWER	C103	1-162-284-31	CERAMIC 150PF 10% 50V
	Δ 1-558-946-11	(UK).....CORD, POWER	C105	1-130-480-00	MYLAR 0.0056MF 5% 50V
	Δ 1-559-819-11	(US,Canadian)...CORD, POWER	C106	1-130-473-00	MYLAR 0.0015MF 5% 50V
917	Δ 1-535-706-11	PLUG, JUMPER	C107	1-124-902-00	ELECT 0.47MF 20% 50V
918	Δ 1-526-565-00	AC PLUG ADAPTOR	C108	1-124-446-11	ELECT 47MF 20% 10V
919	*1-626-795-11	PC BOARD, SIRCS	C109	1-162-286-31	(WG)...CERAMIC 220PF 10% 50V
BP1	*1-535-116-00	TERMINAL 3P	C110	1-162-286-31	(WG)...CERAMIC 220PF 10% 50V
BP2	*1-535-118-00	TERMINAL 5P	C111	1-162-286-31	(WG)...CERAMIC 220PF 10% 50V
BP3	*1-535-139-00	(US,Canadian,E)...BASE POST 22MM (10MM PITCH) 2P	C112	1-162-286-31	(WG)...CERAMIC 220PF 10% 50V
BP4	*1-535-139-00	(US,Canadian)...TERMINAL 2P	C113	1-162-286-31	(WG)...CERAMIC 220PF 10% 50V
BP5	*1-535-139-00	(E)...TERMINAL 2P	C114	1-162-286-31	(WG)...CERAMIC 220PF 10% 50V
BP6	*1-535-115-00	(E)...TERMINAL 2P	C115	1-162-286-31	(WG)...CERAMIC 220PF 10% 50V
BP7	*1-535-116-00	(E)...TERMINAL 3P	C116	1-162-286-31	(WG)...CERAMIC 220PF 10% 50V
BP8	*1-535-114-00	(AEP,UK,WG)....TERMINAL 3P	C117	1-162-286-31	(WG)...CERAMIC 220PF 10% 50V
BP9	*1-535-140-00	(AEP,UK,E,WG)...BASE POST 22MM (10MM PITCH) 3P	C118	1-162-286-31	(WG)...CERAMIC 220PF 10% 50V
C1	Δ 1-161-744-00	CERAMIC 0.01MF 400V	C119	1-162-286-31	(WG)...CERAMIC 220PF 10% 50V
C50	1-124-471-00	ELECT 1000MF 20% 6.3V	C120	1-162-286-31	(WG)...CERAMIC 220PF 10% 50V
C51	1-124-471-00	(US,Canadian,E) ...ELECT 1000MF 20% 6.3V	C121	1-123-875-11	ELECT 10MF 20% 50V
C52	1-124-471-00	(US,Canadian,E) ...ELECT 1000MF 20% 6.3V	C122	1-161-494-00	(WG)...CERAMIC 0.022MF 25V
C53	1-124-471-00	ELECT 1000MF 20% 6.3V	C123	1-161-494-00	(WG)...CERAMIC 0.022MF 25V
C54	1-124-471-00	(US,Canadian,E) ...ELECT 1000MF 20% 6.3V	C124	1-161-494-00	CERAMIC 0.022MF 30% 25V
C55	1-124-471-00	(US,Canadian,E) ...ELECT 1000MF 20% 6.3V	C200	1-162-285-31	(WG)...CERAMIC 180PF 10% 50V
			C201	1-162-282-31	(US,Canadian,AEP,UK,E) ...CERAMIC 100PF 10% 50V

Ref.No.	Part No.	Description				
C202	1-123-875-11	ELECT	10MF	20%	50V	
C203	1-162-284-31	CERAMIC	150PF	10%	50V	
C205	1-130-480-00	MYLAR	0.0056MF	5%	50V	
C206	1-130-473-00	MYLAR	0.0015MF	5%	50V	
C207	1-124-902-00	ELECT	0.47MF	20%	50V	
C208	1-124-446-11	ELECT	47MF	20%	10V	
C209	1-162-286-31	(WG)...CERAMIC	220PF	10%	50V	
C210	1-162-286-31	(WG)...CERAMIC	220PF	10%	50V	
C211	1-162-286-31	(WG)...CERAMIC	220PF	10%	50V	
C212	1-162-286-31	(WG)...CERAMIC	220PF	10%	50V	
C213	1-162-286-31	(WG)...CERAMIC	220PF	10%	50V	
C214	1-162-286-31	(WG)...CERAMIC	220PF	10%	50V	
C215	1-162-286-31	(WG)...CERAMIC	220PF	10%	50V	
C216	1-162-286-31	(WG)...CERAMIC	220PF	10%	50V	
C217	1-162-286-31	(WG)...CERAMIC	220PF	10%	50V	
C218	1-162-286-31	(WG)...CERAMIC	220PF	10%	50V	
C219	1-162-286-31	(WG)...CERAMIC	220PF	10%	50V	
C220	1-162-286-31	(WG)...CERAMIC	220PF	10%	50V	
C300	1-124-927-11	ELECT	4.7MF	20%	50V	
C302	1-124-927-11	ELECT	4.7MF	20%	50V	
C304	1-123-875-11	ELECT	10MF	20%	50V	
C306	1-162-211-31	CERAMIC	33PF	5%	50V	
C307	1-124-927-11	ELECT	4.7MF	20%	50V	
C308	1-124-927-11	ELECT	4.7MF	20%	50V	
C309	1-162-211-31	CERAMIC	33PF	5%	50V	
C310	1-124-446-11	ELECT	47MF	20%	10V	
C311	1-162-217-31	CERAMIC	56PF	5%	50V	
C312	1-124-927-11	ELECT	4.7MF	20%	50V	
C313	1-130-475-00	MYLAR	0.0022MF	5%	50V	
C314	1-136-157-00	FILM	0.022MF	5%	50V	
C315	1-130-481-00	MYLAR	0.0068MF	5%	50V	
C316	1-136-163-00	FILM	0.068MF	5%	50V	
C317	1-123-875-11	ELECT	10MF	20%	50V	
C400	1-124-927-11	ELECT	4.7MF	20%	50V	
C403	1-124-927-11	ELECT	4.7MF	20%	50V	
C404	1-123-875-11	ELECT	10MF	20%	50V	
C406	1-162-211-31	CERAMIC	33PF	5%	50V	
C407	1-124-927-11	ELECT	4.7MF	20%	50V	
C408	1-124-927-11	ELECT	4.7MF	20%	50V	
C409	1-162-211-31	CERAMIC	33PF	5%	50V	
C410	1-124-446-11	ELECT	47MF	20%	10V	
C411	1-162-217-31	CERAMIC	56PF	5%	50V	
C412	1-124-927-11	ELECT	4.7MF	20%	50V	
C413	1-130-475-00	MYLAR	0.0022MF	5%	50V	
C414	1-136-157-00	FILM	0.022MF	5%	50V	
C415	1-130-481-00	MYLAR	0.0068MF	5%	50V	
C416	1-136-163-00	FILM	0.068MF	5%	50V	
C417	1-123-875-11	ELECT	10MF	20%	50V	
C450	1-162-282-31	CERAMIC	100PF	10%	50V	
C452	1-162-282-31	CERAMIC	100PF	10%	50V	
C453	1-130-480-00	MYLAR	0.0056MF	5%	50V	
C454	1-130-479-00	MYLAR	0.0047MF	5%	50V	
C455	1-162-290-31	CERAMIC	470PF	10%	50V	
C458	1-124-472-11	ELECT	470MF	20%	10V	
C459	1-124-472-11	ELECT	470MF	20%	10V	
C460	1-124-927-11	ELECT	4.7MF	20%	50V	
C461	1-162-283-31	CERAMIC	120PF	10%	50V	

Ref.No.	Part No.	Description				
C462	1-162-286-31	CERAMIC	220PF	10%	50V	
C463	1-130-482-00	MYLAR	0.0082MF	5%	50V	
C464	1-130-479-00	MYLAR	0.0047MF	5%	50V	
C465	1-162-290-31	CERAMIC	470PF	10%	50V	
C466	1-124-927-11	ELECT	4.7MF	20%	50V	
C467	1-161-379-00	CERAMIC	0.01MF	20%	16V	
C468	1-136-161-00	FILM	0.047MF	5%	50V	
C469	1-161-379-00	CERAMIC	0.01MF	20%	16V	
C470	1-123-875-11	ELECT	10MF	20%	50V	
C471	1-136-165-00	FILM	0.1MF	5%	50V	
C472	1-136-171-00	FILM	0.33MF	5%	50V	
C473	1-162-290-31	CERAMIC	470PF	10%	50V	
C474	1-130-479-00	MYLAR	0.0047MF	5%	50V	
C475	1-162-211-31	CERAMIC	33PF	5%	50V	
C476	1-130-480-00	MYLAR	0.0056MF	5%	50V	
C477	1-136-158-00	FILM	0.027MF	5%	50V	
C478	1-136-161-00	FILM	0.047MF	5%	50V	
C479	1-130-482-00	MYLAR	0.0082MF	5%	50V	
C480	1-161-379-00	CERAMIC	0.01MF	20%	16V	
C500	1-124-927-11	ELECT	4.7MF	20%	50V	
C501	1-162-292-31	CERAMIC	680PF	10%	50V	
C502	1-124-446-11	ELECT	47MF	20%	10V	
C503	1-161-959-00	CERAMIC	22PF	10%	500V	
C504	1-124-446-11	ELECT	47MF	20%	10V	
C505	1-162-193-31	CERAMIC	3.3PF	10%	50V	
C506	1-161-959-00	CERAMIC	22PF	10%	500V	
C507	1-124-446-11	ELECT	47MF	20%	10V	
C508	1-136-159-00	(US)...FILM	0.033MF	5%	50V	
C508	1-136-163-00	(Canadian,AEP,UK,E,WG)FILM	0.068MF	5%	50V	
C509	1-136-163-00	(Canadian,AEP,UK,E,WG)FILM	0.068MF	5%	50V	
C510	1-136-153-00	(WG)...FILM	0.01MF	5%	50V	
C510A	1-162-596-00	(WG)...CERAMIC	0.022MF		25V	
C511	1-136-153-00	(WG)...FILM	0.01MF	5%	50V	
C600	1-124-927-11	ELECT	4.7MF	20%	50V	
C601	1-162-292-31	CERAMIC	680PF	10%	50V	
C602	1-124-446-11	ELECT	47MF	20%	10V	
C603	1-161-959-00	CERAMIC	22PF	10%	500V	
C604	1-124-446-11	ELECT	47MF	20%	10V	
C605	1-162-193-31	CERAMIC	3.3PF	10%	50V	
C606	1-161-959-00	CERAMIC	22PF	10%	500V	
C607	1-124-446-11	ELECT	47MF	20%	10V	
C608	1-136-159-00	(US)...FILM	0.033MF	5%	50V	
C608	1-136-163-00	(Canadian,AEP,UK,E,WG)FILM	0.068MF	5%	50V	
C609	1-136-163-00	(Canadian,AEP,UK,E,WG)FILM	0.068MF	5%	50V	
C610	1-136-153-00	(WG)...FILM	0.01MF	5%	50V	
C610A	1-162-596-00	(WG)...CERAMIC	0.022MF		25V	
C611	1-136-153-00	(WG)...FILM	0.01MF	5%	50V	
C700	1-124-927-11	ELECT	4.7MF	20%	50V	
C701	1-136-161-00	FILM	0.047MF	5%	50V	
C702	1-124-927-11	ELECT	4.7MF	20%	50V	
C703	1-124-446-11	ELECT	47MF	20%	10V	
C704	1-162-199-31	CERAMIC	10PF	5%	50V	

Ref.No.	Part No.	Description				
C705	1-126-407-51	ELECT	470MF	20%	25V	
C706	1-123-875-11	ELECT	10MF	20%	50V	
C707	1-124-446-11	ELECT	47MF	20%	10V	
C708	1-126-101-11	ELECT	100MF	20%	16V	
C709	1-124-917-11	ELECT	33MF	20%	50V	
C710	1-124-478-11	ELECT	100MF	20%	25V	
C711	1-136-159-00	(US)...FILM	0.033MF	5%	50V	
C711	1-136-163-00	(Canadian,AEP,UK,E,WG) ...FILM	0.068MF	5%	50V	
C712	1-136-163-00	(Canadian,AEP,UK,E,WG) ...FILM	0.068MF	5%	50V	
C750	1-161-494-00	CERAMIC	0.022MF		25V	
C751	1-124-446-11	ELECT	47MF	20%	10V	
C752	1-124-443-00	ELECT	100MF	20%	6.3V	
C753	1-123-875-11	ELECT	10MF	20%	50V	
C754	1-124-477-11	ELECT	47MF	20%	16V	
C755	1-136-153-00	(WG)...FILM	0.01MF	5%	50V	
C801	1-125-416-11	(AEP,UK,WG)...ELECT	10000MF	20%	63V	
C801	1-125-522-11	(US,Canadian,E) ...ELECT	12000MF	20%	71V	
C802	1-125-416-11	(AEP,UK,WG)...ELECT	10000MF	20%	63V	
C802	1-125-522-11	(US,Canadian,E) ...ELECT	12000MF	20%	71V	
C804	1-124-618-11	ELECT	2200MF	20%	35V	
C805	1-124-618-11	ELECT	2200MF	20%	35V	
C807	1-124-360-00	ELECT	1000MF	20%	16V	
C808	1-124-119-00	ELECT	330MF	20%	16V	
C809	1-123-875-11	ELECT	10MF	20%	50V	
C810	1-123-875-11	ELECT	10MF	20%	50V	
C811	1-123-875-11	ELECT	10MF	20%	50V	
C812	1-124-446-11	ELECT	47MF	20%	10V	
C813	1-124-446-11	ELECT	47MF	20%	10V	
C815	1-124-480-11	ELECT	470MF	20%	25V	
C816	1-123-875-11	ELECT	10MF	20%	50V	
C817	1-123-875-11	ELECT	10MF	20%	50V	
C818	1-123-875-11	(E)...ELECT	10MF	20%	50V	
C819	1-161-494-00	CERAMIC	0.022MF		25V	
C900	1-136-153-00	FILM	0.01MF	5%	50V	
C901	1-162-282-31	CERAMIC	100PF	10%	50V	
C902	1-162-282-31	CERAMIC	100PF	10%	50V	
C903	1-124-893-11	ELECT	2200MF	20%	10V	
C904	1-124-927-11	ELECT	4.7MF	20%	50V	
C905	1-124-463-00	ELECT	0.1MF	20%	50V	
C906	1-124-499-11	ELECT	1MF	20%	50V	
C907	1-124-925-11	ELECT	2.2MF	20%	50V	
C908	1-124-925-11	ELECT	2.2MF	20%	50V	
C909	1-130-471-00	MYLAR	0.001MF	5%	50V	
C910	1-161-379-00	CERAMIC	0.01MF	20%	16V	
C911	1-161-379-00	CERAMIC	0.01MF	20%	16V	
C912	1-161-379-00	CERAMIC	0.01MF	20%	16V	
C913	1-124-443-00	ELECT	100MF	20%	6.3V	
C914	1-161-494-00	CERAMIC	0.022MF	30%	25V	
CNJ1	△.1-526-794-11	(AEP,WG).....OUTLET, AC				
CNJ1	△.1-526-751-11	(UK).....OUTLET, AC				
CNJ1	△.1-540-012-11	(US,Canadian,E)...OUTLET, AC				

Note:

The components identified by mark Δ or dotted line with mark Δ are critical for safety. Replace only with part number specified.

Note:

Les composants identifiés par une marque Δ sont critiques pour la sécurité. Ne les remplacer que par une pièce portant le numéro spécifié.

Ref.No.	Part No.	Description
CNJ601*	1-564-508-11	PLUG, CONNECTOR 5P
CNJ602*	1-564-505-21	PLUG, CONNECTOR 2P
CNJ603*	1-564-508-11	PLUG, CONNECTOR 5P
CNJ604*	1-564-505-31	PLUG, CONNECTOR 2P
CNJ605*	1-564-505-11	PLUG, CONNECTOR 2P
CNJ606*	1-564-505-21	PLUG, CONNECTOR 2P
CNJ607*	1-564-505-41	PLUG, CONNECTOR 2P
CNJ608*	1-564-506-11	PLUG, CONNECTOR 3P
CNJ609*	1-564-505-31	PLUG, CONNECTOR 2P
CNJ801*	1-564-501-11	PIN, CONNECTOR 8P
CNJ802*	1-564-502-11	PIN, CONNECTOR 10P
CNJ803*	1-564-502-11	PIN, CONNECTOR 10P
CNJ804*	1-564-497-11	PIN, CONNECTOR 4P
CNJ806*	1-564-336-00	PIN, CONNECTOR 2P
CNJ807*	1-564-337-00	PIN, CONNECTOR 3P
CNJ901	1-566-213-11	PIN, CONNECTOR 4P
CNP701*	1-565-439-11	PIN, CONNECTOR (PCB) 10P
CNP702*	1-565-344-11	PIN, CONNECTOR (PC BOARD) 8P
CNP703*	1-565-440-11	PIN, CONNECTOR (PCB) 12P
CNS701*	1-565-438-11	SOCKET, CONNECTOR (PCB) 10P
CNS702*	1-565-347-11	SOCKET, CONNECTOR (PC BOARD) 8P
CNS703*	1-565-441-11	SOCKET, CONNECTOR (PCB) 12P
D50	8-719-000-26	DIODE US1060M
D51	8-719-000-26	DIODE US1060M
D501	8-719-000-51	DIODE UZL-6L2
D502	8-719-002-85	DIODE US1090M
D503	8-719-002-85	DIODE US1090M
D504	8-719-002-85	DIODE US1090M
D601	8-719-000-51	DIODE UZL-6L2
D602	8-719-002-85	DIODE US1090M
D603	8-719-002-85	DIODE US1090M
D604	8-719-002-85	DIODE US1090M
D700	8-719-000-26	DIODE US1060M
D701	8-719-000-26	DIODE US1060M
D702	8-719-000-26	(Canadian,AEP,UK,E,WG)...DIODE US1060M
D703	8-719-000-26	DIODE US1060M
D704	8-719-000-26	DIODE US1060M
D800	△.8-719-200-80	DIODE D300
D801	△.8-719-200-80	DIODE D300
D802	△.8-719-302-36	DIODE RBV-402-01
D803	△.8-719-511-40	DIODE S1VB10-S
D804	8-719-303-00	DIODE SEL2510C
D805	△.8-719-200-77	(US,Canadian)...DIODE 10E2N
D805	△.8-719-511-40	(AEP,UK,E,WG)...DIODE S1VB10-S
D806	8-719-000-51	DIODE UZL-6L2
D807	8-719-301-38	(AEP,UK,E,WG)...DIODE SEL2210S-C (STAND BY)
D900	8-719-000-26	DIODE US1060M
D901	8-719-000-26	DIODE US1060M
D902	8-719-301-60	DIODE SEL2910A-C (VIDEO 1)
D903	8-719-301-60	DIODE SEL2910A-C (VIDEO 2)
D904	8-719-301-60	DIODE SEL2910A-C (VIDEO 3/CDV)
D905	8-719-301-60	DIODE SEL2910A-C (VIDEO 4)
D906	8-719-301-38	DIODE SEL2210S-C (VIDEO 1)
D907	8-719-301-38	DIODE SEL2210S-C (VIDEO 2)
D908	8-719-301-38	DIODE SEL2210S-C (VIDEO 3/CDV)
D909	8-719-301-38	DIODE SEL2210S-C (VIDEO 4)
D910	8-719-301-38	DIODE SEL2210S-C (TAPE/DAT)

Ref.No.	Part No.	Description	Ref.No.	Part No.	Description
D911	8-719-301-38	DIODE SEL2210S-C (CD)	J100	1-565-320-11	JACK, PIN 6P
D912	8-719-301-38	DIODE SEL2210S-C (TUNER)	J101	1-565-320-11	JACK, PIN 6P
D913	8-719-301-38	DIODE SEL2210S-C (PHONO)	J102	1-565-320-11	JACK, PIN 6P
D914	8-719-000-26	DIODE US1060M	J103	1-565-320-11	JACK, PIN 6P
D915	8-719-000-26	DIODE US1060M	J500	1-507-932-11	JACK (HEADPHONES)
D916	8-719-000-26	DIODE US1060M	L500	*1-420-872-00	COIL, AIR CORE (1.9 UH)
D917	8-719-000-51	DIODE UZL-6L2	L600	*1-420-872-00	COIL, AIR CORE (1.9 UH)
D918	8-719-000-26	DIODE US1060M	L700	*1-420-872-00	COIL, AIR CORE (1.9 UH)
D919	8-719-301-60	DIODE SEL2910A-C (MUTING)	L800	1-408-080-00	INDUCTOR 100UH
D920	8-719-000-26	DIODE US1060M	Q50	8-729-117-54	TRANSISTOR 2SA1175
D921	8-719-000-26	DIODE US1060M	Q51	8-729-117-54	TRANSISTOR 2SA1175
D922	8-719-000-26	DIODE US1060M	Q52	8-729-117-54	TRANSISTOR 2SA1175
D923	8-719-310-03	DIODE SEL4925A-C (DOLBY)	Q53	8-729-117-54	(US,Canadian,E)...TRANSISTOR 2SA1175
D924	8-719-310-03	DIODE SEL4925A-C (HOALL)	Q54	8-729-117-54	(US,Canadian,E)...TRANSISTOR 2SA1175
D925	8-719-310-03	DIODE SEL4925A-C (SIMULATED)	Q55	8-729-117-54	(US,Canadian,E)...TRANSISTOR 2SA1175
D929	8-719-000-26	DIODE US1060M	Q56	8-729-117-54	(US,Canadian,E)...TRANSISTOR 2SA1175
D930	8-719-000-26	(Canadian,AEP,UK,E,WG)...DIODE US1060M	Q57	8-729-117-54	(US,Canadian,E)...TRANSISTOR 2SA1175
D931	8-719-000-26	DIODE US1060M	Q58	8-729-117-54	(US,Canadian,E)...TRANSISTOR 2SA1175
F1	△1-532-237-00	(AEP,UK,E,WG)...FUSE, TIME-LAG (3.15A)	Q500	8-729-107-99	TRANSISTOR 2SC3622A
F1	△1-532-748-00	(US,Canadian)...FUSE (6.3A)	Q501	8-729-697-92	TRANSISTOR 2SA979-G
F2	△1-532-237-00	(E).....FUSE, TIME-LAG (3.15A)	Q502	8-729-108-14	TRANSISTOR 2SA988-F
F2	△1-532-286-00	(AEP,UK,WG).....FUSE, TIME-LAG (2.15A)	Q503	8-729-178-54	TRANSISTOR 2SC2785
IC50	8-759-240-52	(US,Canadian,E)...IC M4052BP	Q504	8-729-178-54	TRANSISTOR 2SC2785
IC51	8-759-240-52	IC M4052BP	Q505	8-729-104-91	TRANSISTOR 2SA1383
IC100	8-759-600-02	IC M5218L	Q506	8-729-107-25	TRANSISTOR 2SD1585
IC101	8-759-805-14	IC LC7822	Q507	8-729-104-18	TRANSISTOR 2SC3514
IC102	8-759-601-43	IC M4066BP	Q508	8-729-178-54	TRANSISTOR 2SC2785
IC202	8-759-601-43	IC M4066BP	Q509	8-729-117-54	TRANSISTOR 2SA1175
IC300	8-759-601-43	IC M4066BP	Q510	8-729-107-53	TRANSISTOR 2SC2275A-P
IC301	8-759-600-02	IC M5218L	Q511	8-729-190-53	TRANSISTOR 2SA985A-P
IC302	8-759-600-02	IC M5218L	Q512	8-729-300-22	(US,Canadian,E)...TRANSISTOR 2SA1215
IC303	8-759-600-02	IC M5218L	Q512	8-729-304-29	(AEP,UK,WG).....TRANSISTOR 2SA1491
IC450	8-759-600-02	IC M5218L	Q513	8-729-300-36	(US,Canadian,E)...TRANSISTOR 2SC2921
IC451	8-759-600-02	IC M5218L	Q513	8-729-304-32	(AEP,UK,WG).....TRANSISTOR 2SC3855
IC452	8-759-403-66	IC MN3007	Q514	8-729-108-06	TRANSISTOR 2SC1841
IC453	8-759-400-11	IC MN3101	Q600	8-729-107-99	TRANSISTOR 2SC3622A
IC454	8-759-600-02	IC M5218L	Q601	8-729-697-92	TRANSISTOR 2SA979-G
IC455	8-759-929-37	IC NE646N	Q602	8-729-108-14	TRANSISTOR 2SA988-F
IC700	8-749-920-29	IC STK-4026	Q603	8-729-178-54	TRANSISTOR 2SC2785
IC701	8-759-111-68	IC UPC1237HA	Q604	8-729-178-54	TRANSISTOR 2SC2785
IC800	8-759-604-49	IC M5F7909	Q605	8-729-104-91	TRANSISTOR 2SA1383
IC801	8-759-604-31	IC M5F7809	Q606	8-729-107-25	TRANSISTOR 2SD1585
IC802	8-759-604-49	IC M5F7909	Q607	8-729-104-18	TRANSISTOR 2SC3514
IC803	8-759-604-33	(E)...IC M5F7812	Q608	8-729-178-54	TRANSISTOR 2SC2785
IC900	8-759-630-57	IC M50720-401SP	Q609	8-729-117-54	TRANSISTOR 2SA1175
IC901	8-749-901-49	IC SBX1492-51	Q610	8-729-107-53	TRANSISTOR 2SC2275A-P
J50	1-563-136-31	JACK, PIN 3P	Q611	8-729-190-53	TRANSISTOR 2SA985A-P
J51	1-565-351-21	JACK, PIN 3P	Q612	8-729-300-22	(US,Canadian,E)...TRANSISTOR 2SA1215
J52	1-565-351-21	JACK, PIN 3P	Q612	8-729-304-29	(AEP,UK,WG).....TRANSISTOR 2SA1491
J53	1-566-846-11	(US,Canadian,E)...CONTROL, (S) TERMINAL 4P (VIDEO 3 IN)	Q613	8-729-300-36	(US,Canadian,E)...TRANSISTOR 2SC2921
J54	1-566-846-11	(US,Canadian,E)...CONTROL, (S) TERMINAL 4P (VIDEO 2 OUT)	Q613	8-729-304-32	(AEP,UK,WG).....TRANSISTOR 2SC3855
J55	1-566-846-11	(US,Canadian,E)...CONTROL, (S) TERMINAL 4P (VIDEO 2 IN)	Q614	8-729-108-06	TRANSISTOR 2SC1841
J56	1-566-846-11	(US,Canadian,E)...CONTROL, (S) TERMINAL 4P (VIDEO 1 OUT)	Q700	8-729-107-99	TRANSISTOR 2SC3622A-K
J57	1-566-846-11	(US,Canadian,E)...CONTROL, (S) TERMINAL 4P (VIDEO 1 IN)	Q701	8-729-900-61	TRANSISTOR DTA114ES
J58	1-566-846-11	(US,Canadian,E)...CONTROL, (S) TERMINAL 4P (MONITOR OUT)	Q702	8-729-900-63	TRANSISTOR DTA124ES
			Q703	8-729-117-54	TRANSISTOR 2SA1175
			Q704	8-729-117-54	TRANSISTOR 2SA1175

Note:

The components identified by mark △ or dotted line with mark △ are critical for safety. Replace only with part number specified.

Note:

Les composants identifiés par une marque △ sont critiques pour la sécurité. Ne les remplacer que par une pièce portant le numéro spécifié.

Ref.No.	Part No.	Description
Q705	8-729-117-54	TRANSISTOR 2SA1175
Q800	8-729-178-54	TRANSISTOR 2SC2785
Q801	8-729-117-54	TRANSISTOR 2SA1175
Q802	8-729-801-93	TRANSISTOR 2SD1387
Q900	8-729-900-36	TRANSISTOR DTC124ES
Q901	8-729-900-63	TRANSISTOR DTA124ES
Q902	8-729-900-36	TRANSISTOR DTC124ES
Q903	8-729-900-63	TRANSISTOR DTA124ES
Q904	8-729-900-36	TRANSISTOR DTC124ES
Q905	8-729-900-63	TRANSISTOR DTA124ES
Q906	8-729-900-36	TRANSISTOR DTC124ES
Q907	8-729-900-36	TRANSISTOR DTC124ES
Q908	8-729-900-36	TRANSISTOR DTC124ES
Q909	8-729-900-36	TRANSISTOR DTC124ES
Q910	8-729-900-63	TRANSISTOR DTA124ES
Q911	8-729-900-63	TRANSISTOR DTA124ES
Q912	8-729-900-63	TRANSISTOR DTA124ES
Q913	8-729-900-63	TRANSISTOR DTA124ES
Q914	8-729-900-63	TRANSISTOR DTA124ES
Q915	8-729-900-63	TRANSISTOR DTA124ES
Q916	8-729-900-36	TRANSISTOR DTC124ES
Q917	8-729-900-63	TRANSISTOR DTA124ES
Q918	8-729-802-22	TRANSISTOR 2SB1014
Q919	8-729-802-34	TRANSISTOR 2SD1388
Q920	8-729-900-63	TRANSISTOR DTA124ES
Q921	8-729-117-54	TRANSISTOR 2SA1175
Q922	8-729-117-54	TRANSISTOR 2SA1175
Q923	8-729-900-63	TRANSISTOR DTA124ES
Q924	8-729-900-63	TRANSISTOR DTA124ES
Q925	8-729-900-63	TRANSISTOR DTA124ES
Q926	8-729-900-63	TRANSISTOR DTA124ES
Q927	8-729-178-54	TRANSISTOR 2SC2785
Q928	8-729-178-54	TRANSISTOR 2SC2785
Q929	8-729-900-36	TRANSISTOR DTC124ES
Q930	8-729-900-63	TRANSISTOR DTA124ES
Q931	8-729-178-54	TRANSISTOR 2SC2785
Q998	8-729-900-36	TRANSISTOR DTC124ES
Q999	8-729-900-63	TRANSISTOR DTA124ES
R41	1-249-405-11	(US,Canadian,E)...CARBON 100 5% 1/4W
R42	1-249-405-11	(US,Canadian,E)...CARBON 100 5% 1/4W
R43	1-249-405-11	(US,Canadian,E)...CARBON 100 5% 1/4W
R44	1-249-405-11	(US,Canadian,E)...CARBON 100 5% 1/4W
R45	1-249-405-11	(US,Canadian,E)...CARBON 100 5% 1/4W
R46	1-249-405-11	(US,Canadian,E)...CARBON 100 5% 1/4W
R47	1-249-405-11	CARBON 100 5% 1/4W
R48	1-249-405-11	CARBON 100 5% 1/4W
R49	1-249-405-11	CARBON 100 5% 1/4W
R50	1-215-394-00	(US,Canadian,E)...CARBON 75 5% 1/4W
R51	1-215-394-00	(US,Canadian,E)...CARBON 75 5% 1/4W
R52	1-247-804-11	CARBON 75 5% 1/4W
R53	1-247-804-11	CARBON 75 5% 1/4W
R54	1-215-394-00	(US,Canadian,E)...CARBON 75 5% 1/4W
R55	1-215-394-00	(US,Canadian,E)...CARBON 75 5% 1/4W
R56	1-247-804-11	CARBON 75 5% 1/4W
R57	1-215-394-00	(US,Canadian,E)...CARBON 75 5% 1/4W
R58	1-215-394-00	(US,Canadian,E)...CARBON 75 5% 1/4W

Ref.No.	Part No.	Description
R59	1-215-394-00	(US,Canadian,E)...CARBON 75 5% 1/4W
R60	1-215-394-00	(US,Canadian,E)...CARBON 75 5% 1/4W
R61	1-247-895-00	CARBON 470K 5% 1/4W
R62	1-249-433-11	CARBON 22K 5% 1/4W
R63	1-249-433-11	CARBON 22K 5% 1/4W
R64	1-247-881-00	CARBON 120K 5% 1/4W
R65	1-249-433-11	CARBON 22K 5% 1/4W
R66	1-249-438-11	CARBON 56K 5% 1/4W
R67	1-249-408-11	CARBON 180 5% 1/4W
R68	1-247-881-00	CARBON 120K 5% 1/4W
R69	1-249-438-11	CARBON 56K 5% 1/4W
R70	1-249-433-11	CARBON 22K 5% 1/4W
R71	1-249-408-11	CARBON 180 5% 1/4W
R72	1-247-881-00	CARBON 120K 5% 1/4W
R73	1-249-438-11	CARBON 56K 5% 1/4W
R74	1-249-408-11	CARBON 180 5% 1/4W
R75	1-247-881-00	(US,Canadian,E)...CARBON 120K 5% 1/4W
R76	1-249-438-11	(US,Canadian,E)...CARBON 56K 5% 1/4W
R77	1-249-433-11	(US,Canadian,E)...CARBON 22K 5% 1/4W
R78	1-249-408-11	(US,Canadian,E)...CARBON 180 5% 1/4W
R79	1-247-881-00	(US,Canadian,E)...CARBON 120K 5% 1/4W
R80	1-249-438-11	(US,Canadian,E)...CARBON 56K 5% 1/4W
R81	1-249-433-11	(US,Canadian,E)...CARBON 22K 5% 1/4W
R82	1-249-408-11	(US,Canadian,E)...CARBON 180 5% 1/4W
R83	1-247-881-00	(US,Canadian,E)...CARBON 120K 5% 1/4W
R84	1-249-438-11	(US,Canadian,E)...CARBON 56K 5% 1/4W
R85	1-249-408-11	(US,Canadian,E)...CARBON 180 5% 1/4W
R86	1-247-881-00	(US,Canadian,E)...CARBON 120K 5% 1/4W
R87	1-249-438-11	(US,Canadian,E)...CARBON 56K 5% 1/4W
R88	1-249-433-11	(US,Canadian,E)...CARBON 22K 5% 1/4W
R89	1-249-408-11	(US,Canadian,E)...CARBON 180 5% 1/4W
R90	1-247-881-00	(US,Canadian,E)...CARBON 120K 5% 1/4W
R91	1-249-438-11	(US,Canadian,E)...CARBON 56K 5% 1/4W
R92	1-249-433-11	(US,Canadian,E)...CARBON 22K 5% 1/4W
R93	1-249-408-11	(US,Canadian,E)...CARBON 180 5% 1/4W
R94	1-247-881-00	(US,Canadian,E)...CARBON 120K 5% 1/4W
R95	1-249-438-11	(US,Canadian,E)...CARBON 56K 5% 1/4W
R96	1-249-408-11	(US,Canadian,E)...CARBON 180 5% 1/4W
R97	1-247-895-00	(US,Canadian,E)...CARBON 470K 5% 1/4W
R98	1-247-895-00	(US,Canadian,E)...CARBON 470K 5% 1/4W
R100	1-249-418-11	(WG)...CARBON 1.2K 5% 1/4W
R101	1-249-441-11	CARBON 100K 5% 1/4W
R102	1-249-411-11	(US,Canadian,AEP,UK,E) ...CARBON 330 5% 1/4W
R102	1-249-413-11	(WG)...CARBON 470 5% 1/4W
R103	1-249-416-11	CARBON 820 5% 1/4W
R104	1-249-441-11	CARBON 100K 5% 1/4W
R105	1-247-897-11	CARBON 560K 5% 1/4W
R106	1-249-437-11	CARBON 47K 5% 1/4W
R107	1-249-441-11	CARBON 100K 5% 1/4W
R108	1-249-409-11	CARBON 220 5% 1/4W
R109	1-249-418-11	CARBON 1.2K 5% 1/4W
R110	1-249-418-11	CARBON 1.2K 5% 1/4W
R111	1-249-413-11	CARBON 470 5% 1/4W
R112	1-249-418-11	CARBON 1.2K 5% 1/4W
R113	1-249-418-11	CARBON 1.2K 5% 1/4W
R114	1-249-418-11	CARBON 1.2K 5% 1/4W

Ref.No.	Part No.	Description				
R115	1-249-413-11	CARBON	470	5%	1/4W	
R116	1-249-418-11	CARBON	1.2K	5%	1/4W	
R117	1-249-413-11	CARBON	470	5%	1/4W	
R118	1-249-418-11	CARBON	1.2K	5%	1/4W	
R119	1-249-413-11	CARBON	470	5%	1/4W	
R120	1-249-418-11	CARBON	1.2K	5%	1/4W	
R121	1-249-429-11	CARBON	10K	5%	1/4W	
R122	1-249-433-11	CARBON	22K	5%	1/4W	
R123	1-249-433-11	CARBON	22K	5%	1/4W	
R124	1-249-433-11	CARBON	22K	5%	1/4W	
R200	1-249-418-11	(WG)...CARBON	1.2K	5%	1/4W	
R201	1-249-441-11	CARBON	100K	5%	1/4W	
R202	1-249-411-11	(US,Canadian,AEP,UK,E) ...CARBON	330	5%	1/4W	
R202	1-249-413-11	(WG)...CARBON	470	5%	1/4W	
R203	1-249-441-11	CARBON	100K	5%	1/4W	
R204	1-249-416-11	CARBON	820	5%	1/4W	
R205	1-247-897-11	CARBON	560K	5%	1/4W	
R206	1-249-437-11	CARBON	47K	5%	1/4W	
R207	1-249-441-11	CARBON	100K	5%	1/4W	
R208	1-249-409-11	CARBON	220	5%	1/4W	
R209	1-249-418-11	CARBON	1.2K	5%	1/4W	
R210	1-249-418-11	CARBON	1.2K	5%	1/4W	
R211	1-249-413-11	CARBON	470	5%	1/4W	
R212	1-249-418-11	CARBON	1.2K	5%	1/4W	
R213	1-249-418-11	CARBON	1.2K	5%	1/4W	
R214	1-249-418-11	CARBON	1.2K	5%	1/4W	
R215	1-249-413-11	CARBON	470	5%	1/4W	
R216	1-249-418-11	CARBON	1.2K	5%	1/4W	
R217	1-249-413-11	CARBON	470	5%	1/4W	
R218	1-249-418-11	CARBON	1.2K	5%	1/4W	
R219	1-249-413-11	CARBON	470	5%	1/4W	
R220	1-249-418-11	CARBON	1.2K	5%	1/4W	
R300	1-249-417-11	CARBON	1K	5%	1/4W	
R301	1-249-438-11	CARBON	56K	5%	1/4W	
R302	1-249-441-11	CARBON	100K	5%	1/4W	
R303	1-249-429-11	CARBON	10K	5%	1/4W	
R304	1-249-429-11	CARBON	10K	5%	1/4W	
R307	1-247-887-00	CARBON	220K	5%	1/4W	
R308	1-249-429-11	CARBON	10K	5%	1/4W	
R309	1-249-429-11	CARBON	10K	5%	1/4W	
R310	1-249-417-11	CARBON	1K	5%	1/4W	
R311	1-249-441-11	CARBON	100K	5%	1/4W	
R312	1-249-430-11	CARBON	12K	5%	1/4W	
R313	1-247-887-00	CARBON	220K	5%	1/4W	
R314	1-249-427-11	CARBON	6.8K	5%	1/4W	
R315	1-249-415-11	CARBON	680	5%	1/4W	
R316	1-249-434-11	CARBON	27K	5%	1/4W	
R317	1-249-422-11	CARBON	2.7K	5%	1/4W	
R318	1-249-417-11	CARBON	1K	5%	1/4W	
R400	1-249-417-11	CARBON	1K	5%	1/4W	
R401	1-249-438-11	CARBON	56K	5%	1/4W	
R402	1-249-441-11	CARBON	100K	5%	1/4W	
R403	1-249-429-11	CARBON	10K	5%	1/4W	
R404	1-249-429-11	CARBON	10K	5%	1/4W	
R405	1-249-429-11	CARBON	10K	5%	1/4W	
R406	1-249-429-11	CARBON	10K	5%	1/4W	

Ref.No.	Part No.	Description				
R407	1-247-887-00	CARBON	220K	5%	1/4W	
R408	1-249-429-11	CARBON	10K	5%	1/4W	
R409	1-249-429-11	CARBON	10K	5%	1/4W	
R410	1-249-417-11	CARBON	1K	5%	1/4W	
R411	1-249-441-11	CARBON	100K	5%	1/4W	
R412	1-249-430-11	CARBON	12K	5%	1/4W	
R413	1-247-887-00	CARBON	220K	5%	1/4W	
R414	1-249-427-11	CARBON	6.8K	5%	1/4W	
R415	1-249-415-11	CARBON	680	5%	1/4W	
R416	1-249-434-11	CARBON	27K	5%	1/4W	
R417	1-249-422-11	CARBON	2.7K	5%	1/4W	
R418	1-249-417-11	CARBON	1K	5%	1/4W	
R450	1-249-441-11	CARBON	100K	5%	1/4W	
R451	1-249-441-11	CARBON	100K	5%	1/4W	
R452	1-249-428-11	CARBON	8.2K	5%	1/4W	
R453	1-249-428-11	CARBON	8.2K	5%	1/4W	
R454	1-249-431-11	CARBON	15K	5%	1/4W	
R455	1-249-428-11	CARBON	8.2K	5%	1/4W	
R456	1-249-405-11	CARBON	100	5%	1/4W	
R457	1-249-413-11	CARBON	470	5%	1/4W	
R458	1-249-413-11	CARBON	470	5%	1/4W	
R459	1-249-441-11	CARBON	100K	5%	1/4W	
R460	1-249-441-11	CARBON	100K	5%	1/4W	
R461	1-249-426-11	CARBON	5.6K	5%	1/4W	
R462	1-249-426-11	CARBON	5.6K	5%	1/4W	
R463	1-249-437-11	CARBON	47K	5%	1/4W	
R464	1-249-440-11	CARBON	82K	5%	1/4W	
R465	1-249-414-11	CARBON	560	5%	1/4W	
R466	1-247-887-00	CARBON	220K	5%	1/4W	
R467	1-249-428-11	CARBON	8.2K	5%	1/4W	
R468	1-249-428-11	CARBON	8.2K	5%	1/4W	
R469	1-249-431-11	CARBON	15K	5%	1/4W	
R470	1-249-428-11	CARBON	8.2K	5%	1/4W	
R471	1-249-429-11	CARBON	10K	5%	1/4W	
R472	1-249-427-11	CARBON	6.8K	5%	1/4W	
R473	1-247-889-00	CARBON	270K	5%	1/4W	
R474	1-247-885-00	CARBON	180K	5%	1/4W	
R475	1-249-439-11	CARBON	68K	5%	1/4W	
R476	1-249-433-11	CARBON	22K	5%	1/4W	
R477	1-249-435-11	CARBON	33K	5%	1/4W	
R478	1-249-437-11	CARBON	47K	5%	1/4W	
R479	1-249-433-11	CARBON	22K	5%	1/4W	
R480	1-249-408-11	CARBON	180	5%	1/4W	
R481	1-249-423-11	CARBON	3.3K	5%	1/4W	
R482	1-249-405-11	CARBON	100	5%	1/4W	
R483	1-247-887-00	CARBON	220K	5%	1/4W	
R484	1-247-881-00	CARBON	120K	5%	1/4W	
R485	1-249-425-11	CARBON	4.7K	5%	1/4W	
R500	1-249-417-11	CARBON	1K	5%	1/4W	
R501	1-249-417-11	CARBON	1K	5%	1/4W	
R502	1-249-437-11	CARBON	47K	5%	1/4W	
R503	1-249-423-11	CARBON	3.3K	5%	1/4W	
R504	1-249-411-11	CARBON	330	5%	1/4W	
R505	△1-247-704-11	CARBON	220	5%	1/4W	F
R506	△1-247-704-11	CARBON	220	5%	1/4W	F
R507	1-249-437-11	CARBON	47K	5%	1/4W	
R508	1-249-421-11	CARBON	2.2K	5%	1/4W	

Note:
The components identified by mark Δ or dotted line with mark Δ are critical for safety. Replace only with part number specified.

Note:
Les composants identifiés par une marque Δ sont critiques pour la sécurité. Ne les remplacer que par une pièce portant le numéro spécifié.

Ref.No.	Part No.	Description				
R509	.1-247-692-11	CARBON	22	5%	1/4W	F
R510	1-249-429-11	CARBON	10K	5%	1/4W	
R511	1-249-435-11	CARBON	33K	5%	1/4W	
R512	1-249-433-11	CARBON	22K	5%	1/4W	
R513	1-249-435-11	CARBON	33K	5%	1/4W	
R514	1-249-419-11	CARBON	1.5K	5%	1/4W	
R515	1-249-414-11	CARBON	560	5%	1/4W	
R516	△.1-247-692-11	CARBON	22	5%	1/4W	F
R517	△.1-247-700-11	CARBON	100	5%	1/4W	F
R518	△.1-247-700-11	CARBON	100	5%	1/4W	F
R519	△.1-247-719-11	CARBON	3.3K	5%	1/4W	F
R520	△.1-247-713-11	CARBON	1K	5%	1/4W	F
R521	△.1-247-713-11	CARBON	1K	5%	1/4W	F
R522	△.1-247-717-11	CARBON	2.2K	5%	1/4W	F
R523	△.1-249-455-11	CARBON	4.7	5%	1/4W	F
R524	△.1-247-745-11	CARBON	330	5%	1/2W	F
R525	△.1-249-455-11	CARBON	4.7	5%	1/4W	F
R526	△.1-214-789-00	RES, METAL PLATE 0.1			5W	
R527	△.1-214-789-00	RES, METAL PLATE 0.1			5W	
R528	1-249-441-11	CARBON	100K	5%	1/4W	
R529	△.1-247-700-11	CARBON	100	5%	1/4W	F
R530	1-249-430-11	CARBON	12K	5%	1/4W	
R531	1-247-727-11	CARBON	10	5%	1/2W	
R532	1-247-727-11	CARBON	10	5%	1/2W	
R533	1-249-437-11	CARBON	47K	5%	1/4W	
R534	1-247-727-11	(WG)...CARBON	10	5%	1/2W	
R535	1-247-727-11	(WG)...CARBON	10	5%	1/2W	
R536	△.1-216-433-00	METAL OXIDE	1.2K	5%	1W	F
R600	1-249-417-11	CARBON	1K	5%	1/4W	
R601	1-249-417-11	CARBON	1K	5%	1/4W	
R602	1-249-437-11	CARBON	47K	5%	1/4W	
R603	1-249-423-11	CARBON	3.3K	5%	1/4W	
R604	1-249-411-11	CARBON	330	5%	1/4W	
R605	△.1-247-704-11	CARBON	220	5%	1/4W	F
R606	△.1-247-704-11	CARBON	220	5%	1/4W	F
R607	1-249-437-11	CARBON	47K	5%	1/4W	
R608	1-249-421-11	CARBON	2.2K	5%	1/4W	
R609	△.1-247-692-11	CARBON	22	5%	1/4W	F
R610	1-249-429-11	CARBON	10K	5%	1/4W	
R611	1-249-435-11	CARBON	33K	5%	1/4W	
R612	1-249-433-11	CARBON	22K	5%	1/4W	
R613	1-249-435-11	CARBON	33K	5%	1/4W	
R614	1-249-419-11	CARBON	1.5K	5%	1/4W	
R615	1-249-414-11	CARBON	560	5%	1/4W	
R616	△.1-247-692-11	CARBON	22	5%	1/4W	F
R617	△.1-247-700-11	CARBON	100	5%	1/4W	F
R618	△.1-247-700-11	CARBON	100	5%	1/4W	F
R619	△.1-247-719-11	CARBON	3.3K	5%	1/4W	F
R620	△.1-247-713-11	CARBON	1K	5%	1/4W	F
R621	△.1-247-713-11	CARBON	1K	5%	1/4W	F
R622	△.1-247-717-11	CARBON	2.2K	5%	1/4W	F
R623	△.1-249-455-11	CARBON	4.7	5%	1/4W	F
R624	△.1-247-745-11	CARBON	330	5%	1/2W	F
R625	△.1-249-455-11	CARBON	4.7	5%	1/4W	F
R626	△.1-214-789-00	RES, METAL PLATE 0.1			5W	
R627	△.1-214-789-00	RES, METAL PLATE 0.1			5W	
R628	1-249-441-11	CARBON	100K	5%	1/4W (BIAS)	

Ref.No.	Part No.	Description				
R629	△.1-247-700-11	CARBON	100	5%	1/4W	F
R630	1-249-430-11	CARBON	12K	5%	1/4W	
R631	1-247-727-11	CARBON	10	5%	1/2W	
R632	1-247-727-11	CARBON	10	5%	1/2W	
R633	1-249-438-11	CARBON	56K	5%	1/4W	
R634	1-247-727-11	(WG)...CARBON	10	5%	1/2W	
R635	1-247-727-11	(WG)...CARBON	10	5%	1/2W	
R636	△.1-216-433-00	METAL OXIDE	1.2K	5%	1W	F
R700	1-249-417-11	CARBON	1K	5%	1/4W	
R701	1-249-417-11	CARBON	1K	5%	1/4W	
R702	1-249-417-11	CARBON	1K	5%	1/4W	
R703	1-249-438-11	CARBON	56K	5%	1/4W	
R704	1-249-408-11	CARBON	180	5%	1/4W	
R705	1-249-438-11	CARBON	56K	5%	1/4W	
R706	1-249-423-11	CARBON	3.3K	5%	1/4W	
R707	1-249-421-11	CARBON	2.2K	5%	1/4W	
R708	1-247-727-11	CARBON	10	5%	1/2W	
R709	1-247-727-11	CARBON	10	5%	1/2W	
R710	1-249-421-11	CARBON	2.2K	5%	1/4W	
R727	1-249-417-11	CARBON	1K	5%	1/4W	
R750	1-249-429-11	CARBON	10K	5%	1/4W	
R751	1-249-441-11	CARBON	100K	5%	1/4W	
R752	1-249-429-11	CARBON	10K	5%	1/4W	
R753	1-249-438-11	CARBON	56K	5%	1/4W	
R754	1-249-433-11	CARBON	22K	5%	1/4W	
R755	1-247-727-11	(WG)...CARBON	10	5%	1/2W	
R756	1-249-433-11	CARBON	22K	5%	1/4W	
R758	1-249-421-11	CARBON	2.2K	5%	1/4W	
R759	1-249-421-11	CARBON	2.2K	5%	1/4W	
R760	1-249-405-11	CARBON	100	5%	1/4W	
R761	1-249-421-11	CARBON	2.2K	5%	1/4W	
R762	1-249-417-11	CARBON	1K	5%	1/4W	
R800	△.1-217-477-00	FUSIBLE	4.7	5%	1W	
R801	△.1-217-477-00	FUSIBLE	4.7	5%	1W	
R802	1-249-410-11	CARBON	270	5%	1/4W	
R803	1-249-421-11	CARBON	2.2K	5%	1/4W	
R804	1-249-421-11	CARBON	2.2K	5%	1/4W	
R805	1-249-410-11	CARBON	270	5%	1/4W	
R806	1-249-411-11	CARBON	330	5%	1/4W	
R807	1-249-425-11	CARBON	4.7K	5%	1/4W	
R808	1-249-408-11	CARBON	180	5%	1/4W	
R900	1-249-433-11	CARBON	22K	5%	1/4W	
R901	1-249-433-11	CARBON	22K	5%	1/4W	
R902	1-249-433-11	CARBON	22K	5%	1/4W	
R903	1-247-819-81	CARBON	330	5%	1/4W	
R904	1-249-412-11	CARBON	390	5%	1/4W	
R905	1-249-412-11	CARBON	390	5%	1/4W	
R906	1-249-433-11	CARBON	22K	5%	1/4W	
R907	1-249-433-11	CARBON	22K	5%	1/4W	
R908	1-249-433-11	CARBON	22K	5%	1/4W	
R909	1-249-433-11	CARBON	22K	5%	1/4W	
R910	1-249-433-11	CARBON	22K	5%	1/4W	
R911	1-249-433-11	CARBON	22K	5%	1/4W	
R912	1-249-433-11	CARBON	22K	5%	1/4W	
R913	1-249-433-11	CARBON	22K	5%	1/4W	
R914	1-247-903-00	CARBON	1M	5%	1/4W	
R916	1-249-441-11	CARBON	100K	5%	1/4W	

Note:
The components identified by mark △ or dotted line with mark △ are critical for safety. Replace only with part number specified.

Note:
Les composants identifiés par une marque △ sont critiques pour la sécurité. Ne les remplacer que par une pièce portant le numéro spécifié.

Ref.No.	Part No.	Description
R917	1-249-433-11	CARBON 22K 5% 1/4W
R918	1-249-414-11	CARBON 560 5% 1/4W
R919	1-249-429-11	CARBON 10K 5% 1/4W
R922	1-249-394-11	CARBON 12 5% 1/4W
R923	1-249-419-11	CARBON 1.5K 5% 1/4W
R925	1-249-394-11	CARBON 12 5% 1/4W
R926	1-249-417-11	CARBON 1K 5% 1/4W
R927	1-244-871-91	CARBON 820 5% 1/2W
R928	1-249-441-11	CARBON 100K 5% 1/4W
R929	1-249-425-11	CARBON 4.7K 5% 1/4W
R930	1-249-433-11	CARBON 22K 5% 1/4W
R931	1-249-433-11	CARBON 22K 5% 1/4W
R932	1-249-425-11	CARBON 4.7K 5% 1/4W
R933	1-249-441-11	CARBON 100K 5% 1/4W
R934	1-249-437-11	CARBON 47K 5% 1/4W
R935	1-249-437-11	CARBON 47K 5% 1/4W
R936	1-249-437-11	CARBON 47K 5% 1/4W
R937	1-249-437-11	CARBON 47K 5% 1/4W
R938	1-249-429-11	CARBON 10K 5% 1/4W
R939	1-249-429-11	CARBON 10K 5% 1/4W
R940	1-249-417-11	CARBON 1K 5% 1/4W
R941	1-249-429-11	CARBON 10K 5% 1/4W
R942	1-249-417-11	CARBON 1K 5% 1/4W
R943	1-249-393-11	CARBON 10 5% 1/4W
R944	1-244-871-91	CARBON 820 5% 1/2W
R945	1-244-871-91	CARBON 820 5% 1/2W
R946	1-249-423-11	CARBON 3.3K 5% 1/4W
R946A	1-249-425-11	CARBON 4.7K 5% 1/4W
R947	1-249-441-11	CARBON 100K 5% 1/4W
R949	1-249-433-11	CARBON 22K 5% 1/4W
RV300	1-238-190-11	RES, VAR, CARBON 250K (BALANCE)
RV301	1-238-159-11	RES, VAR, CARBON (MOTOR)250KX3 (VOLUME)
RV302	1-238-156-11	RES, VAR, CARBON 250K/250K (BALANCE)
RV303	1-238-157-11	RES, VAR, CARBON 100K/100K (TREBLE)
RV304	1-238-157-11	RES, VAR, CARBON 100K/100K (BASS)
RV700	1-238-158-11	RES, VAR, CARBON 100K (SURROUND LEVEL)
RY700	1-515-356-00	RELAY (MUTING)
RY900	1-515-617-11	(AEP,UK,E,WG)...RELAY (POWER)
RY900	1-515-701-11	(US,Canadian)...RELAY (POWER)

Ref.No.	Part No.	Description
S1	△1-571-515-11	(E)...VOLTAGE SELECTOR
S500	1-570-270-11	SWITCH, PUSH (2 KEY)(SPEAKERS)
S900	1-554-303-21	SWITCH, KEY BOARD (VIDEO 1)
S901	1-554-303-21	SWITCH, KEY BOARD (VIDEO 2)
S902	1-554-303-21	SWITCH, KEY BOARD (VIDEO 3/CDV)
S903	1-554-303-21	SWITCH, KEY BOARD (VIDEO 4)
S904	1-554-303-21	SWITCH, KEY BOARD (TAPE/DAT)
S905	1-554-303-21	SWITCH, KEY BOARD (CD)
S906	1-554-303-21	SWITCH, KEY BOARD (TUNER)
S907	1-554-303-21	SWITCH, KEY BOARD (PHONO)
S908	1-571-436-11	SWITCH, KEY BOARD (SYSTEM POWER)
S909	1-554-303-21	SWITCH, KEY BOARD (MUTING)
S910	1-554-303-21	SWITCH, KEY BOARD (SUR OFF)
S911	1-554-303-21	SWITCH, KEY BOARD (DOLBY)
S912	1-554-303-21	SWITCH, KEY BOARD (HALL)
S913	1-554-303-21	SWITCH, KEY BOARD (SIMULATED)
T1	△1-449-265-11	(US,Canadian)...TRANSFORMER, POWER
T1	△1-449-300-11	(AEP,UK,WG)....TRANSFORMER, POWER
T1	△1-449-301-11	(E).....TRANSFORMER, POWER
T2	△1-449-296-11	(US,Canadian)...TRANSFORMER, POWER
T2	△1-449-297-11	(AEP,UK,WG)....TRANSFORMER, POWER
T2	△1-449-299-11	(E).....TRANSFORMER, POWER
TM500	1-536-706-00	TERMINAL BOARD (SP)
TM700	1-537-156-11	TERMINAL BOARD (SPEAKER)
TP1	*1-560-063-00	PIN, CONNECTOR 5P
X900	1-567-254-11	OSCILLATOR, CERAMIC (2MHz)

ACCESSORY & PACKING MATERIAL

1-463-983-11	REMOTE COMMANDER (RM-P102)
3-703-450-03	(US)...INSTRUCTION
3-786-058-11	(AEP,UK,E).....MANUAL, INSTRUCTION
3-786-058-21	(US,Canadian)...MANUAL, INSTRUCTION
3-786-058-31	(Canadian).....MANUAL, INSTRUCTION
3-786-058-41	(AEP,WG).....MANUAL, INSTRUCTION
4-922-048-01	COVER, BATTERY (REMOTE COMMANDER)
4-915-702-01	LABEL, CAUTION, DOLBY SURROUND
*4-921-346-01	CUSHION
*4-921-349-01	INDIVIDUAL CARTON

Note:
The components identified by mark Δ or dotted line with mark Δ are critical for safety. Replace only with part number specified.

Note:
Les composants identifiés par une marque Δ sont critiques pour la sécurité. Ne les remplacer que par une pièce portant le numéro spécifié.

SECTION 6

TROUBLE SHOOTING

Should any problem persist after you have made these checks, consult your nearest Sony service facility. Before going through the check list below, first refer back to the connection and operating procedures.

Trouble		Possible Causes
Power cannot be turned on.		Check if the power cord is disconnected from the power outlet.
Audio	No audio.	<ul style="list-style-type: none"> • Check for faulty connection. • Check for short-circuited speaker terminals. • The shorting plug of the EQUALIZER jacks are disconnected. • Check that the connected equipment, such as a graphic equalizer, is turned on.
	No audio from one channel.	<ul style="list-style-type: none"> • Check if the BALANCE is set to an extreme position. • Check if the speaker cord or connection cord is disconnected.
	Distorted audio.	• Check if the audio volume setting is above the maximum permissible input of the speakers.
	Obscure instrument positioning, with lack of bass sound.	• Check if the positive (+) speaker terminal on the main body is not connected to the negative (-) terminal on the speaker, and vice versa.
	Hum or noise.	<ul style="list-style-type: none"> • Check that the grounding wire of the turntable is connected securely. • Check that the connection cords are inserted securely into jacks.
Video	No video.	<ul style="list-style-type: none"> • Check that the connections are correct. • Check that the correct FUNCTION is selected.
	Unclear video, low image quality.	• Check if there is any nearby source of noise.
Programmable Commander	Remote-control operation cannot be performed.	<ul style="list-style-type: none"> • Check that the batteries are loaded correctly. • Check if there is any obstacle between the programmable commander and amplifier. • Check if the batteries are exhausted. • Check if the mode selector is set to USER STD in remote-control operation using programmed signals.
	The remote-control signal cannot be programmed. The READY lamp does not light.	<ul style="list-style-type: none"> • Place both remote commanders apart from the source of noise. • The batteries are exhausted.
	The LEARNED indicator blinks.	• The internal memory capacity is full.